

---

*WANdisco CVS MultiSite  
Administration Guide*

---



## Revision History

REVISION	DATE
1.0	December 2008
2.0	February 2009

This material is confidential to WANdisco and may not be disclosed in whole or in part to any third party nor used in any manner whatsoever other than for the purposes expressly consented to by WANdisco in writing.

This material is also copyright protected and may not be reproduced, stored in a retrieval system or transmitted in any form or by any means in whole or in part without the express written consent of WANdisco.



# Contents

1	Introduction .....	1
1.1	WANdisco MultiSite Concepts .....	3
1.1.1	How Replication Works .....	3
1.1.1.1	Singleton Quorum .....	3
1.1.1.2	Majority Quorum .....	3
1.1.1.3	Unanimous Quorum .....	4
1.1.2	Replication Example .....	4
1.1.3	WANdisco is Listening .....	5
1.1.4	Synchronized Stop of All Sites .....	7
1.2	Replication and Site or Network Failures .....	8
1.2.1	Site Failures .....	8
1.2.2	Network Failures .....	8
1.3	Establishing a Replication Baseline .....	8
1.4	Terms .....	9
2	Recommended Deployment Practices .....	10
2.1	MultiSite Administrator Pre-requisites .....	10
2.2	Physical Environment .....	10
2.2.1	WANdisco and CVS Password Files .....	11
2.3	Firewalls and Virus Scanners .....	11
2.3.1	Firewalls .....	11
2.3.2	Virus Scanners .....	11
2.4	Deployment Checklist .....	12
2.5	Supported Procols .....	14
2.5.1	SSH Protocol - Client Side Direct SSH Method .....	14
2.5.1.1	Authentication with cvsrelay .....	16
2.5.1.2	Configuring cvsrelay .....	16
2.5.2	pserver Protocol .....	19
2.5.2.1	Configuring (x)inetd Limits .....	19
2.6	Changing CVS Port on Unix Flavor .....	19
2.7	Changing CVS Port on CVSNT .....	20

# Contents, cont'd

3	Installation	21
3.1	First Time Installation of First Site	21
3.1.1	Specifying MultiSite Settings	23
3.1.2	Specifying CVS Settings	24
3.1.3	Initializing First Site	26
3.1.4	Setting the WANdisco Run-As User	27
3.1.5	Validating the Installation	27
3.2	Specifying Subsequent Sites	29
3.2.1	Creating the Replication Group	30
3.2.2	Packaging the CVS Repository?	31
3.2.3	Packaging Subsequent Sites	32
3.2.4	At Each Additional Site	34
3.2.5	Releasing First Site to Users	34
3.3	Activating Subsequent Sites	34
3.3.1	New Site Quarantined	35
3.3.1.1	Verifying the Installation	36
3.3.1.2	Taking a Site Out of Quarantine	36
3.4	Installing Upgrades	37
3.4.1	Stop WANdisco	38
3.4.2	Export WANdisco Data	38
3.4.3	Preparing the Sites	38
3.4.4	At the Install Site	38
3.4.5	Running the Install Program	39
3.4.6	Importing WANdisco Data	39
4	Using the Admin Console	40
4.1	Starting the Admin Console	40
4.2	The Security Page	41
4.2.1	Left Side Menu	41
4.3	The System Page	41
4.3.1	Left Side Menu	41
4.4	The Proxy Page	43
4.4.1	Left Side Menu	43
4.5	The Reports Page	47

## Contents, cont'd

4.6	The Dashboard .....	47
4.6.1	Pending Transactions .....	48
4.6.2	Completed Transactions .....	49
4.6.3	Refreshing the Dashboard Display .....	49
4.6.4	Transaction Status .....	49
5	Managing Users .....	51
5.1	Is WANdisco Controlling the Password File? .....	51
5.2	Creating or Deleting Users .....	52
5.3	Listing and Searching for Users .....	52
5.4	Importing Users .....	53
5.4.1	Having CVS Users Change Their Passwords .....	53
6	Procedures .....	55
6.1	Temporarily Disabling CVS Access at Selected Sites .....	55
6.1.1	Temporarily Disabling CVS Access at Selected Sites .....	55
6.1.2	Temporarily Disabling CVS Access at All Sites .....	55
6.2	Establishing a Baseline for Replication .....	56
6.2.1	Copying the Subversion Database .....	56
6.2.2	Synchronizing With an Older Remote Copy .....	56
6.2.3	Copying Over the Network .....	57
6.2.4	Shipping on a Physical Medium .....	57
6.3	Performing a Synchronized Stop .....	58
6.4	Adding a Site to the Replication Group .....	60
6.5	Removing a Site from the Replication Group .....	60
6.6	Changing a prefs.xml File .....	60
6.6.1	Changing One Site's prefs.xml File .....	60
6.6.2	Changing All Sites' prefs.xml File .....	61
6.7	Verifying That WANdisco is Working .....	61
6.8	Installing a .jar File Patch .....	62
6.9	Changing WANdisco's Root Login .....	62
6.9.1	Changing the Password .....	63
6.10	Adding Another Repository To An Existing Group .....	64
6.11	Restricting PSERVER Access to CVS MultiSite Host .....	65
6.12	Using CVS admin -l to Lock Parts of CVS Repository .....	66

## Contents, cont'd

6.13	Managing CVS Security .....	66
6.14	Using CVS Triggers for Sending E-mails .....	67
6.15	Replicating User/Auth Database .....	67
6.16	Finding the Last Committed Transaction .....	68
6.17	Verifying System Integrity .....	68
7	Replicator Management .....	70
7.1	Changing the Quorum Type .....	70
7.2	Rotating the Distinguished Node .....	70
7.3	Configuring Two Replication Groups On One Server .....	72
7.4	Selective Replication .....	73
7.5	Setting WANdisco to Start Up on System Boot .....	74
7.6	Setting WANdisco Up as a Windows Service .....	76
7.7	Deferred Writes .....	77
7.8	About the Watchdog Mode .....	79
7.9	Temporary Files .....	80
7.10	Concurrency Control .....	80
8	Troubleshooting .....	81
8.1	How Do I Get WANdisco Support? .....	81
8.1.1	How Do I Run the Talkback Script? .....	81
8.2	VPN, NAT, Firewall Timeouts .....	81
8.3	A Site Is In Read-Only Mode .....	83
8.4	Replication Processes .....	84
8.4.1	Connection Request Timeout Messages .....	84
8.4.2	One-to-One Mapping For cvsroot and Replicator .....	84
8.4.3	When I Commit, Why is WANdisco Being Bypassed? .....	84
8.4.4	CVS: Deferred Writes with Long Transactions .....	85
8.4.5	WinCVS Client Responds "Exited Normally with Code 1" ...	86
8.4.6	WinCVS Wants Passphrase - SSH Access to WANdisco ...	86
8.4.7	With WinCVS and SSH, Commits Not Replicated .....	86
8.4.8	No Submitted Lines in Log File After Commits .....	87

## Contents, cont'd

8.5	Error Messages	87
8.5.1	Why Am I Getting Permission Errors for Files?	87
8.5.2	Replicator Aporting with System Error Message	88
8.5.3	Aborted CVS Transaction with "I HATE YOU" Message	89
8.5.4	Missing License Key File	90
8.5.5	I'm Getting a SEVERE Exception	90
8.6	WinCVS - Timeouts Large Commits Can Corrupt Sandbox	91
8.7	Oops!	91
8.7.1	I Directly Committed to CVS, How Do I Rsync?	91
8.7.2	I'm Getting a SEVERE Exception	92
8.7.3	I Pressed Ctrl-C During a CVS Command!	92
8.7.4	CVS Login Appears to Hang	93
8.8	CVSNT Generates CVSLock Error Message	94
9	Frequently Asked Questions	95
9.1	Why Are So Many Java Processes Running?	95
9.2	Do I Need the Same CVS Version for All Servers?	95
9.3	Can I Store Logs or Content on NFS?	95
9.4	Why is Set Up Configuring IP Addresses as 0.0.0.0?	96
9.5	Should I Worry About Time Changes?	96
9.6	Does WANdisco Support Dynamic DNS?	96
9.7	Can I Use SSH Tunnel to Navigate a Firewall?	97
9.8	CVS Tagging and Branching Support	98
9.9	Using SSH Access With NIS-based User Database	98
9.10	How Do I Know cvsrelay is Being Invoked?	99
9.11	Advisory: CVS Add Bug in All CVS Client Versions	100
9.12	Advisory: Zlib Compression Bug in 1.12.12, 1.12.13	100
9.13	Advisory: Avoid Force Commit with CVS Commits	101
9.14	Advisory: CVS 1.12.13 Bug In Import	101
9.15	WANdisco Authentication	101
9.15.1	CVS Password	101
9.16	How WANdisco Handles CVS Authentication	102
9.17	About WANdisco Log Files	103
<b>Appendix A - Installing Java and Perl</b>		<b>A - 1</b>

# 1 Introduction

Welcome to the WANdisco world of replication. CVS is designed to run as a central server to which multiple CVS clients connect. WANdisco's replication technology makes it possible to have multiple active replicas of a CVS repository that are in synch. The CVS replicas can be anywhere on a WAN - distributed throughout a company's campus or throughout the world. WANdisco users experience the performance of a local CVS repository, with the semantics of a single shared CVS repository. We call this "active replication with one-copy-equivalence."

Replication implicitly ensures that each replica acts as a hot backup to every other replica. If a local server does experience a problem that takes it offline, local users experience a disruption in service, while the rest of the replication group continues unaffected. WANdisco does offer a High Availability solution that ensures no disruption in service. Even if a local CVS server failed, local backups take over so service is uninterrupted.

The following illustration shows a replication group with five CVS servers.

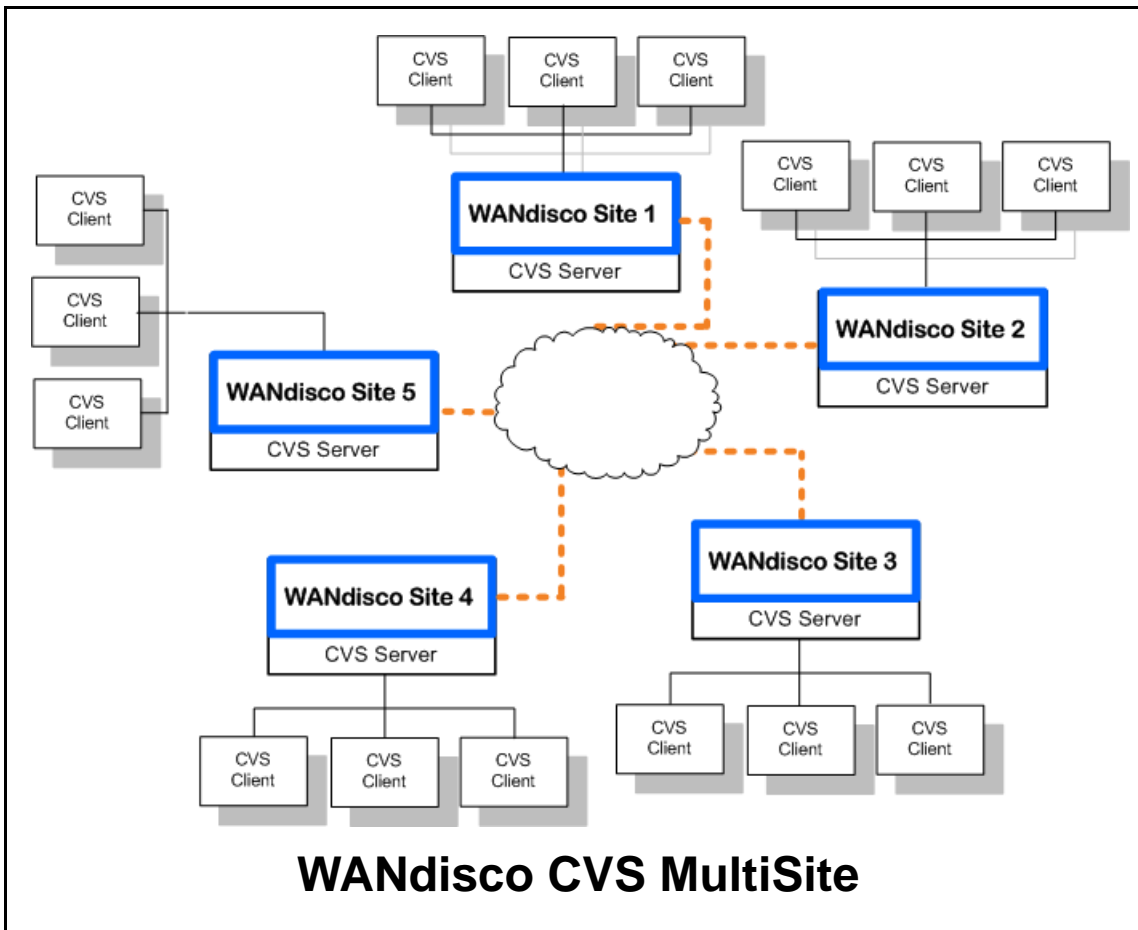

WANdisco MultiSite has the Admin Console, a web-based user interface, to administer and monitor the replication group.

WANdisco CVS MultiSite functions as a proxy to the CVS server. An instance of the proxy operates at each replica. All the communication paths involved in the operation of the product are illustrated in the diagram below.

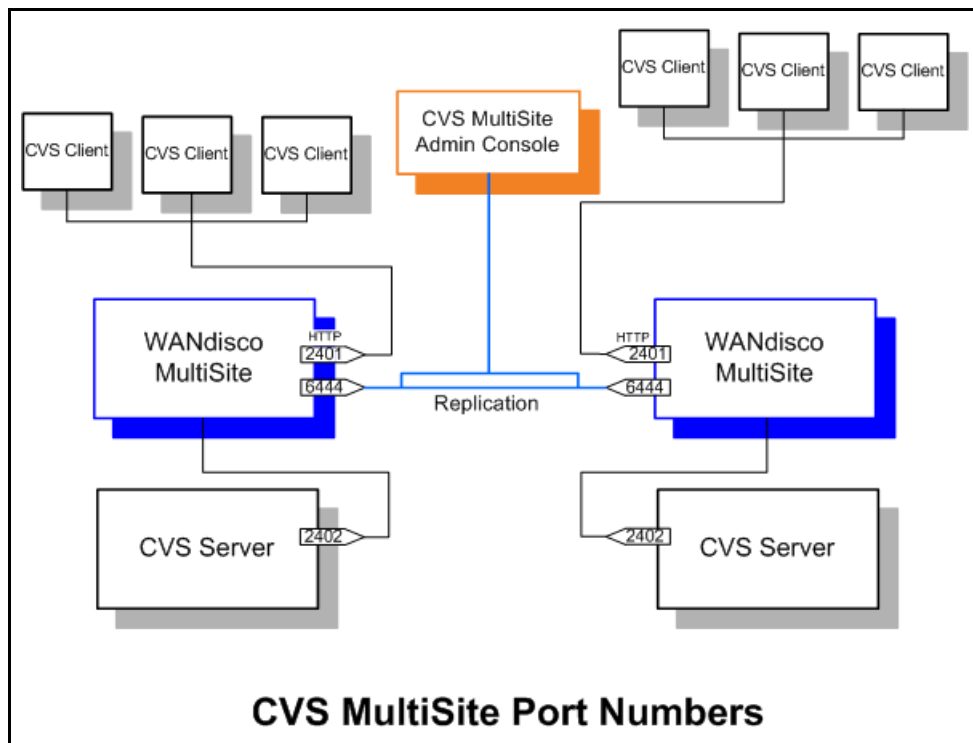

## 1.1 WANdisco MultiSite Concepts

All MultiSite sites are synchronized at all times: each CVS repository is a functional replica of the others. WANdisco replication technology is the concept of one repository, multiplied. Because there are multiple synchronized repositories, each replicated site is effectively a current hot backup, which makes disaster recovery easy to plan and implement.

The CVS usernames and passwords on all repository hosts must match. This is required because WANdisco creates a peer-to-peer replication system. Any replica of the CVS repository is accessible by every valid CVS user. WANdisco offers the user the option of having WANdisco manage the CVS password file.

### 1.1.1 How Replication Works

The sites in the replication group are continuously coordinating the CVS write transactions users are making. The group establishes transaction ordering through the agreement of a quorum of replicas. By default, CVS MultiSite uses a Singleton Response quorum, which means that only one of the sites decides on the transaction order. For singleton quorum, the site that decides transaction ordering is called the distinguished node. So, with a Singleton Response quorum, if the replication group has five sites adding transactions to the transaction queue, only one site determines the position of each transaction in the transaction sequence.

#### 1.1.1.1 Singleton Quorum

The Singleton quorum offers the fastest response time for those users working at the distinguished node, because as soon as the distinguished node determines that a transaction can be processed in the correct order, WANdisco sends that transaction to the CVS server. Any replica except the distinguished node can go down, but the replication group continues. However, the Singleton quorum also represents a single point of failure, since replication halts if the distinguished node fails.

You can schedule the distinguished node to rotate to different sites around the world, to “follow the sun.” Rotating the distinguished node allows other sites to take advantage of the quickest response time when they are most active. See [6.9, Changing WANdisco’s Root Login](#).

#### 1.1.1.2 Majority Quorum

Majority Response is another quorum option, whereby you specify that a majority of the sites must agree on transaction order before any transaction is committed.

Having a majority quorum ensures that if one site goes down in a replication group, even the distinguished node, the other sites can continue uninterrupted, as long as a majority of the sites remain available. The replication group replays the missing transactions when that site rejoins the group.

In a majority quorum, the distinguished node's role is a tie-breaker. For example, in a five site replication group, three sites make the quorum (three sites must agree about transaction ordering). If one of those sites is down, leaving four sites, and two sites want one transaction first, and the other two want another transaction first, then the site that is the distinguished node gets a weighted vote. The group with the distinguished node determines the transaction ordering.

### 1.1.1.3 Unanimous Quorum

The last quorum option is unanimous response, which requires that all replicators must be reachable to assist in transaction ordering.

## 1.1.2 Replication Example

Here is an overview of what occurs when a write transaction is received by any replicator in the replication group.

- Step 1 The originating client sends the transaction to CVS MultiSite, which passes it along through the replication group.
- Step 2 Transaction data is successfully received by the quorum (the distinguished node for Singleton quorum, or a majority of sites for Majority quorum). The quorum assigns the transaction a Global Sequence Number (GSN).
- Step 3 After receiving the transaction, each CVS MultiSite passes the transaction data to its local CVS server.
- Step 4 Each local CVS server processes the transaction.
- Step 5 CVS MultiSite waits for CVS to complete the transaction. CVS MultiSite only marks the transaction complete when CVS returns a completion status. If for some reason replication goes down during this process (the replicator crashes, is stopped by an admin or the server it's running on shuts down), CVS MultiSite marks the transaction as not complete, and it gets reprocessed upon replication restart. This allows the recovery logic to work properly.

### 1.1.3 WANdisco is Listening

There is a field in the Admin Console that tells you whether WANdisco is listening or not. This represents whether WANdisco is listening, or accepting any incoming CVS client requests. Replication still continues among the WANdisco sites, whether WANdisco is listening or not at one or more sites.

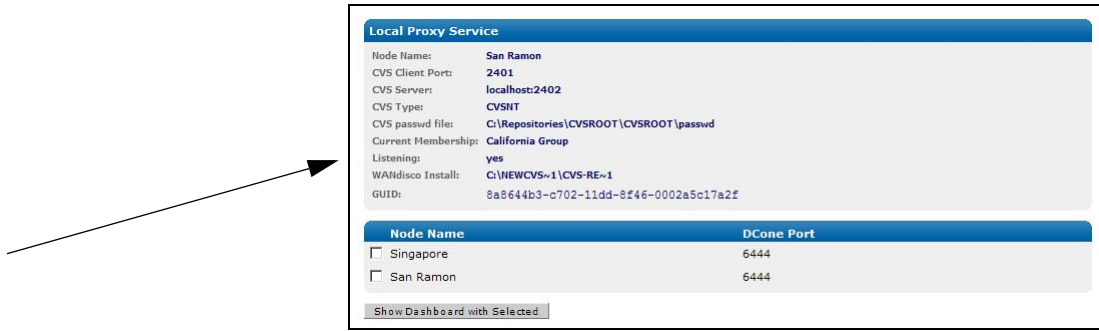

You can turn the listening on and off through the Admin Console (through the **Start Proxy** and **Stop Proxy** commands). The Admin Console is described in Chapter 4, [Using the Admin Console](#). Issuing the **Stop Proxy** command on a site puts that CVS server in read-only mode.

The following illustration shows Sites 2 and 5 are not listening. (An administrator executed the **Stop Proxy** command for those sites.) Replication continues, and Sites 2 and 5 are still receiving and processing replicated transactions originating from the other sites. However, CVS users at Sites 2 and 5 cannot make any write transactions.

Once an administrator issues the **Start Proxy** command for Sites 2 and 5, the local CVS users can again issue CVS commands.

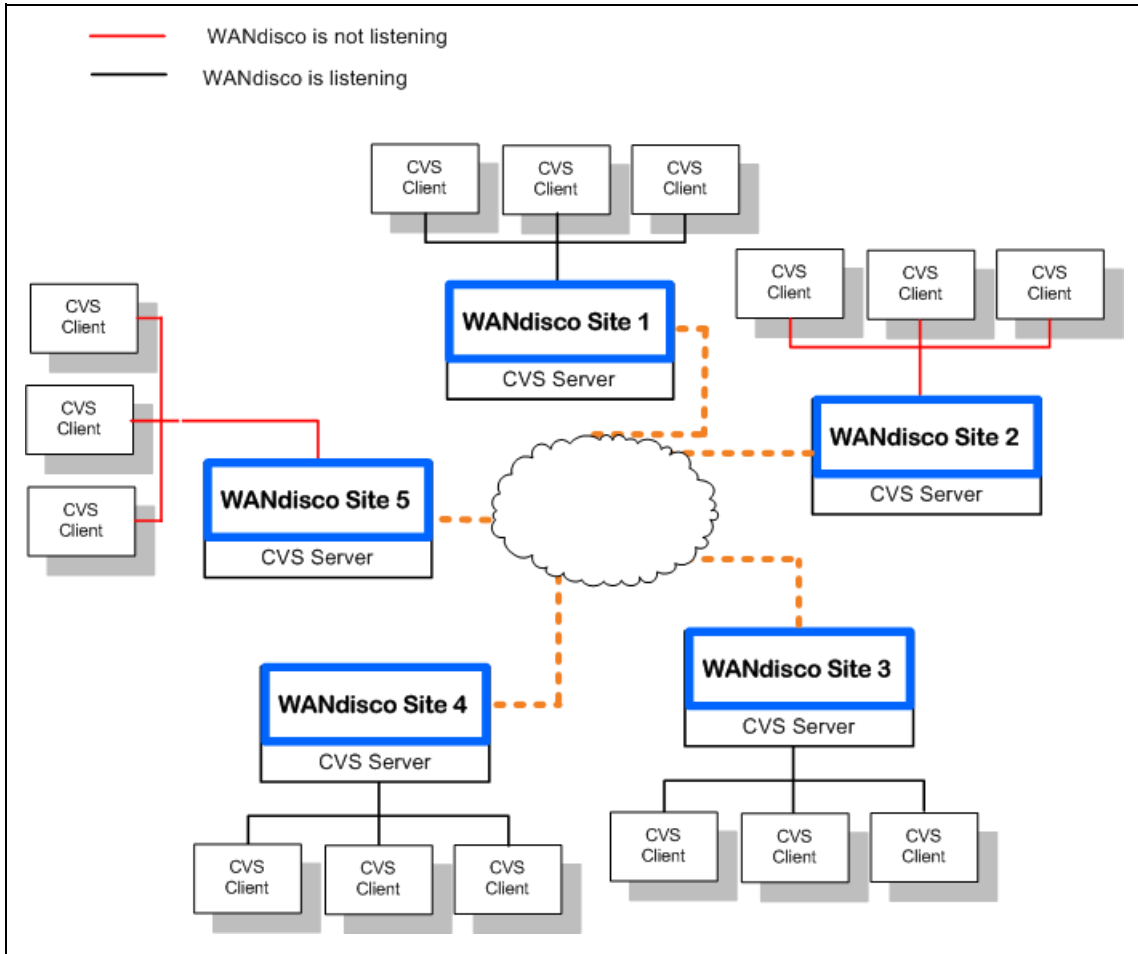

Please follow your company guidelines in regards to notifying CVS users of maintenance.

### 1.1.4 Synchronized Stop of All Sites

When a WANdisco administrator issues a **synchronized stop** command, the CVS servers go into read-only mode. Pending transactions are suspended. CVS users continue to have read access to the repository, but cannot perform write operations, such as **commit** or **lock**.

When a WANdisco administrator issues a **resume** command, the WANdisco proxies go out of read-only mode and begin accepting write transactions.

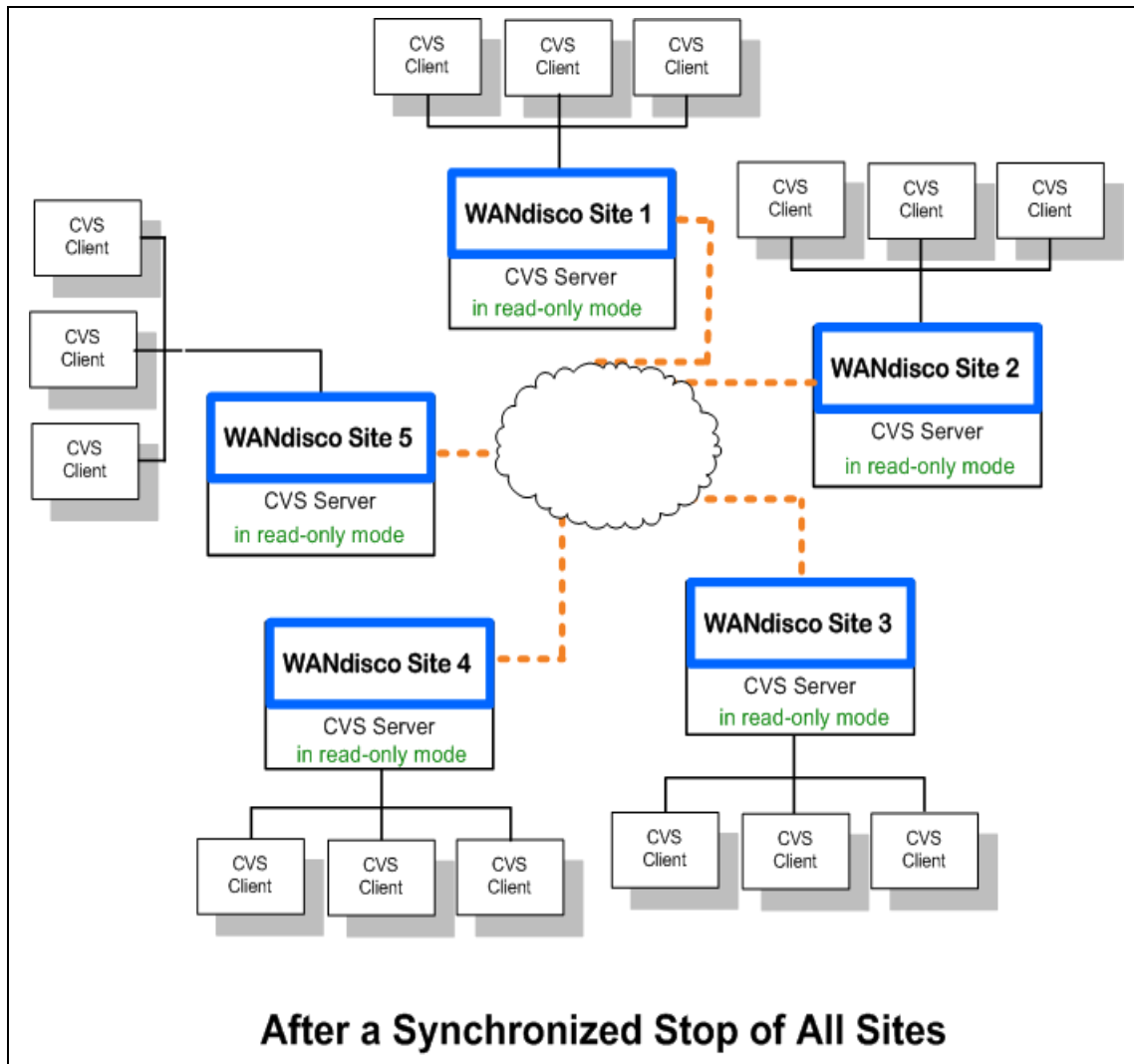

## 1.2 Replication and Site or Network Failures

MultiSite defaults to singleton quorum, which ensures continuous operation of the replication group, as long as the distinguished node is up. That is, if there are five nodes in a replication group, and three go down or are unreachable, then replication continues for the other two nodes, as long as the distinguished node has not gone down. For the other three sites, replication is suspended until the errored site re-establishes contact with the quorum. Replication then replays the missing transactions at that site.

### 1.2.1 Site Failures

Say you have a five site replication group, spread across three continents. One of the sites goes down. Replication continues at the remaining sites, as long as the quorum is reached, although users connecting to the downed site are offline until the site comes back up.

As soon as a site comes back up, the replication group catches up the site on its missing transactions, so that all sites are again synchronized.

### 1.2.2 Network Failures

If a network link goes down and outside connectivity is completely lost, then replication halts and CVS users are prevented from performing a write operation (tag, commit, etc.) that requires a quorum. Read operations (like up, co, log, etc.) continue to work with the stale data.

When connectivity is restored or the errored server comes back online, the local replicator syncs up with the replication group automatically. First, the local replicator consults its local recovery journal (similar to a database redo log), and then, if necessary, attempts recovery from any of the quorum sites.

The recovery infrastructure and details of WANdisco fault-tolerance can be found at <http://www.wandisco.com/pdf/dcone-whitepaper.pdf>.

## 1.3 Establishing a Replication Baseline

When you deploy CVS MultiSite, you must ensure that all the repositories start out in sync, meaning that all of them are identical. Once CVS MultiSite is deployed, WANdisco's replication technology ensures they remain in sync.

You start with one CVS repository, referred to as a replication baseline. To create this baseline, follow the procedure in [6.2, Establishing a Baseline for Replication](#).

## 1.4 Terms

You should familiarize yourself with these terms.

TERM	DEFINITION
replica	a CVS instance that is an exact equivalent or copy of another CVS instance. In WANdisco's MultiSite product, a replica is also called a site.
replicator	It is the intermediary that acts as an application proxy/gateway between CVS clients and a given CVS server. Each <i>Replica</i> has an associated <i>Replicator</i> . It coordinates with other peer replicators to ensure that all replicas of the SCM repositories stay in sync with each other.
replication group	a collection of replicators that work together to keep replicas CVS repository in sync.
one copy equivalence	all replicas are functionally equivalent copies of each other
GUID	Globally Unique Identifier. WANdisco CVS MultiSite assigns each site a GUID on installation. The sites identify each other by their GUIDs.
site	a server on which is installed a replicator and a replica. The sites comprise the replication group.
distinguished node	The distinguished node acts as a tie breaker for a majority quorum when there are an even number of nodes, making the final decision on replicator operations.
Quorum	A set of sites that can reach agreement to determine transaction order. In the case of an even number of nodes, the distinguished node settles a conflict. Quorum is defined in the prefs.xml file. MultiSite by default has Singleton Response quorum.
prefs.xml	The preferences files contain information on the replication group. Each site contains all preference files for the entire replication group. The files are specific to each site. The preference files are located in <code>cvs-replicator/config</code> .
SCM Repository	Software Configuration Management repository like CVS
SCM Server	A network server that provides remote access to an SCM Repository
installDir	this is the installation directory for WANdisco MultiSite
DConE	WANdisco's Distributed Coordinated Engine, the software engine underlying replication
Install node	The node where you run the CVS MultiSite install program. This is the first site in your replication group.

## 2 Recommended Deployment Practices

---

### 2.1 MultiSite Administrator Pre-requisites

This guide is intended for a CVS administrator or a user who is reasonably comfortable with:

- Setting up a CVS based repository
- Configuring inetd/xinetd service on Unix/Cygwin or Windows service
- Installing Perl
- Installing Java
- Unix or Windows system administration

If you don't meet the above pre-requisites, you may want to contact your CVS administrator or request that WANdisco perform a professional install for you.

You can have one MultiSite administrator for your replication group; one person can administer all sites through the Admin Console. The username and password is identical for all sites, which makes it easier for an admin to work between the various site's Admin Consoles.

That said, there should be at least one person at each site who is familiar with WANdisco, as sites distributed throughout the world could need attention if a problem arises.

### 2.2 Physical Environment

WANdisco strongly recommends that you follow these guidelines to ensure the successful installation and use of CVS MultiSite:

- The contents of `cvsrcroot` directories on all the replicas match. Make sure the initial contents are exactly the same, including the repository UUID.
- The CVS user/passwords on all repository hosts should match.
- running servers for each site in the replication group, pre-configured with
  - ◆ the same operating system
  - ◆ the same version of CVS server
  - ◆ matching file and directory level permissions on CVS repositories
  - ◆ a command line zip/unzip utility
  - ◆ Java (see [Appendix A - Installing Java and Perl](#))
  - ◆ Perl (see [Appendix A - Installing Java and Perl](#))
  - ◆ browser with network access to all servers
- e-mail from WANdisco containing the tar file link and attached production licence key file

## 2.2.1 WANdisco and CVS Password Files

WANdisco offers to control the CVS password files. If WANdisco controls the password files, any user you set up in WANdisco is also set up in CVS. (WANdisco and CVS must be running on the same servers at all sites.)

The majority of WANdisco customers elect to have WANdisco handle the passwords. The Admin Console offers an easy way to manage users and passwords.

During installation, you identify the CVS password file's location, and WANdisco incorporates it into the replication group. If you have a lot of CVS users, you can bulk import your users into WANdisco. This is discussed in section [5.4, Importing Users](#).

All replicas should have user information for all the users. The best way to ensure this is to have WANdisco control the CVS password files.

## 2.3 Firewalls and Virus Scanners

### 2.3.1 Firewalls

You must determine if WANdisco sits inside a firewall or outside of one. If WANdisco sits inside a firewall, it is untouched by the firewall and you need take no action.

However, if WANdisco sits outside a firewall, you must configure the firewall so that the port numbers you specify during installation are not blocked or filtered.

### 2.3.2 Virus Scanners

If you have a virus scanner running on your network, you must configure it to not filter traffic on the ports you specify during installation.

## 2.4 Deployment Checklist

You may be familiar with this checklist from an evaluation copy of CVS MultiSite. It is included here as reference..

<b>System Setup ❖ All sites must share the same operating system</b>	
Supported Operating Systems	Fedora (32 or 64 bit): 6, 7, 8, 9 Red Hat Linux Enterprise Server (32 or 64 bit): 4, 5.2 Sun Solaris (32 or 64 bit): 9, 10 Linux: Linux kernel 2.6 or higher CentOS-4 Windows Server, (32 or 64 bit) 2003  Please <a href="#">read this</a> for more information on NPTL.  <b>Note:</b> VMware has a tendency to become unresponsive due to memory paging issues even without WANdisco present. Extra tuning may be needed to ensure optimal performance.
CVS Server Version	Must be the same on all sites. CVS version 1.11.17 - 1.11.23 CVSNT 2.0.x
CVS Client Version	Compatible with local CVS servers
System Memory	Ensure RAM and swapping containers are at least three or four times the largest CVS file you have. Recommended: 1 GB RAM; 2 GB swapping container
Disk Space	<ul style="list-style-type: none"> <li>• CVS: depends on the number of projects and issues</li> <li>• MultiSite Transaction Journal: Recommended - equivalent of seven days of changes</li> </ul>
File Descriptor limit	Ensure hard and soft limits are set to 64000 or higher. Check with the <code>ulimit</code> or <code>limit</code> command.
Journaling File System	Replicator logs should be on a journaling file system, for example, ext3 on Linux or VXFS from Veritas. Notes: NTFS is not a journaling file system: ext4 is a journaling file system, however WANdisco does not support its use because of its deferred writes.
Maximum User Process Limit	At least three times the number of CVS users.
Java	Install JDK 1.5.0. <b>Note:</b> There should not be any spaces or control characters in the path where Java is installed. For example, <code>c:\Program Files\java</code> does not work with WANdisco as a JAVA install directory. See <a href="#">Appendix A - Installing Java and Perl</a> .
Perl	Install version 5.6.1 or later. See <a href="#">Appendix A - Installing Java and Perl</a> .

<b>Network Setup</b>	
Reserved Ports (i.e. 6444, another port for synchronizing)	CVS MultiSite needs a dedicated port (default is 6444) as well as an HTTP port. WANdisco recommends having another port available so that you can synchronize your repositories if necessary. If your network has a firewall, notify the firewall of the port numbers.
Firewall virus scanner	Notify the firewall virus scanner of the CVS MultiSite port numbers.
Persistent Connection Keep Alive	Ensure VPN doesn't reset persistent connections for WANdisco, or else ensure there are no RST bugs
DNS Setup	Best to use IP address for WANdisco related hostnames, or else ensure there is DNS availability
<b>CVS pserver Set Up</b>	
Use port 2401 for WANdisco	Using the standard port 2401 avoids confusion. If you are not going to use 2401 for the WANdisco port, rename the pserver entry
file permissions in CVS-ROOT	Does the CVS user have write permissions? See article at <a href="http://www.linux.ie/articles/tutorials/managingaccesswith-cvs.php?style=printer">http://www.linux.ie/articles/tutorials/managingaccesswith-cvs.php?style=printer</a> .
The --allow-root option for cvsroots	Is the [x]inetd conf verified for cvspserver set up?
CVS triggers (loginfo, etc) for e-mail	Ensure e-mail triggers only fire from one location. See <a href="#">6.14, Using CVS Triggers for Sending E-mails</a> .
CVS commitinfo triggers	Ensure deterministic behavior at each site (either yes or no)
CVS tmpdir has adequate space	Defaults to /tmp : Ensure the size is three times the largest file
<b>Xinetd/Inetd Set Up for cvspserver (Not applicable to Windows Platform)</b>	
/etc/services cvspserver port	Modify cvspserver port to avoid conflict with WANdisco port. We recommend changing cvspserver 2401/tcp and 2401/udp to cvspserver 2402/tcp and 2402/udp. Please make sure that there is only one cvspserver entry. For example, you cannot have cvspserver on 2401 and 2402.
/etc/xinetd.d/cvspserver	Renamed service file or changed cvspserver port to avoid conflict with WANdisco port.
Increase Connection Per Second (CPS) limit	For example, increased to "10000 30"
per_source limit	Make it unlimited
instances limit	Make it unlimited
Restarted [x]inetd daemon	Ensure changes go into effect by restarting. This can be accomplished by executing the following command as <b>root</b> : <code>/sbin/service xinetd restart</code>
<b>CVS MultiSite Application Server</b>	

Agreement Threads	Tune based on number of concurrent CVS writers
Reader/Writer Network IO Thread Pool	Tune based on CVS client connection rate, file transfer rate
ConnectionKeepAlive timeout	Tune inactivity timeout for persistent DConeNet/DFTP connections based on VPN/WAN router set up
Message Queue Max Thread Pool Size	Tune based on CVS write concurrency
Maximum connections per IO thread	Tune if active CVS user population is large (greater than 100)
Log Rotation	Modify <code>log.properties</code>
Disk space for recovery journal	Provision large disk for <code>logs/tmp</code> , at least number of commits within a two to four hour window
<b>SSH Set Up For CVS Client Side</b>	
<code>/etc/prefs.conf</code>	Generated <code>prefs.conf</code> at setup or with <code>install-cvsrelay</code> utility
<code>CVSROOT/passwd</code>	Ensure same <code>cvsrelay</code> password for each user in <code>CVSROOT/passwd</code> file, generated using <code>cvspasswd</code> utility
<b>Notify users to flush their client cache.</b>	

## 2.5 Supported Procols

WANdisco supports either `pserver` or `SSH`. These protocols are mutually exclusive.

### 2.5.1 SSH Protocol - Client Side Direct SSH Method

We will walk through an example with `SSH` as the remote shell.

Set `CVS_RSH` to point to `ssh` or `ssh.exe`, depending on the platform. For Windows, if you use a Putty-based `ssh` client, set `CVS_RSH` to the path to `plink.exe`.

Ensure that your `SSH` credentials are accessible from the machine where you run `CVS` client. For example, if you have a private key, you may want to use the `ssh-agent` (pageant for Putty) and `ssh-add` to have `SSH` pre-register your private key. Use the bundled `cvsrelay` executable as the `CVS_SERVER`. This can be done in two ways:

- all client environments should specify an environment variable `CVS_SERVER` to point to the bundled `cvsrelay` executable. For example, using `tcsh`:

```
setenv CVS_SERVER <path-to-WANdisco-install>/bin/cvsrelay
```

- If you don't want the clients to modify their environment, you can create a link or rename `cvsrelay` to `cvs` and modify the `PATH` so that the `ssh` daemon (`sshd`) invokes `cvsrelay` instead of `cvs` when a CVS client connects to it. If `sshd` is launched via the `init.d` startup script, you could modify the script that starts `sshd` to set the `PATH` to point to `cvsrelay` `bin` directory before any other path element. This lets you essentially invoke `cvsrelay` when a CVS client request comes in. The `cvsrelay` executable then is able to relay CVS request/response packets from `sshd` to the WANdisco CVS replicator.

```
> cd cvs-replicator/bin
> pwd
cvs-replicator/bin
> ln -s cvsrelay cvs
```

Due to security concerns, on most UNIXs, `sshd` is typically compiled with a hardwired `PATH`. In this case, setting the `PATH` in the `init.d` `sshd` startup script does not work. This can typically be confirmed via:

```
> strings `which sshd` | grep -i bin
...
/usr/bin:/bin:/usr/sbin:/sbin
...
```

If you see a colon separated string like above, that might be the compiled in `PATH`. Alternatively you may look at the first couple of lines in `/etc/ssh/sshd_config`:

```
#$OpenBSD: sshd_config,v 1.65 2003/08/28 12:54:34 markus Exp $
# This is the sshd server system-wide configuration file. See
# sshd_config(5) for more information.
# This sshd was compiled with PATH=/usr/bin:/bin:/usr/sbin:/sbin
```

If you determine that your `sshd` has a path hardwired at compilation time, you could do one of the following:

- Recompile `sshd` with `PATH` to `cvsrelay` ahead of standard `cvs` executable.
- The cleanest approach is to rename `cvs` to something like `cvs.org` and change references to `cvs` in `xinet.d/cvspserver` to point to `cvs.org`. Finally, link `cvsrelay` into `/usr/bin` or any system directory that is on `sshd` compiled in `PATH`.

### 2.5.1.1 Authentication with cvsrelay

If you use `cvsrelay`, you must set up the CVS server's password database in the `$CVSROOT/CVSROOT/passwd` file. The passwords in this file are encrypted using the standard UNIX `crypt()` function, so it is possible to cut and paste from the `/etc/passwd` (on some systems `/etc/shadow`) file. Since the authentication is already done via `sshd`, all we need to do is select a single system password and have all users in the `CVSROOT/passwd` file share the same password.

In essence, the `CVSROOT/passwd` file would look like:

```
Bach:1sOp854gDF3DY
Mozart:1sOp854gDF3DY
Handel:1sOp854gDF3DY
```

All users, as you can see, share the same password. A default `passwd` file can be copied from `cvs-replicator/config/passwd-template`. The template file already contains the default password used by `cvsrelay`. If you decide to over-ride the default password, you have to modify the configuration (`/etc/prefs.conf`) for `cvsrelay` to include the new system password. You can also use the bundled utility `cvs-replicator/bin/cvspasswd` to generate `crypt()` password for `CVSROOT/passwd` file:

```
$ cvspasswd
Enter CVS password :
CVSROOT/passwd : sa0Pk81ulv7qc
CVSRelay Password : 117:99:121:32:73:121:60:121
```

Also, the `CVSROOT/config` file needs to turn off system authentication:

```
#Set this to "no" if pserver shouldn't check system users/passwords
SystemAuth=no
# Put CVS lock files in this directory rather than directly in the repository.
#LockDir=/var/lock/cvs
```

The above scheme is essentially delegating the credentials that were obtained after authenticating with `sshd` to the `cvs` server as shown below.

The CVS user authenticates with the `ssh` daemon, which then invokes `cvsrelay` with the user ID of the secure shell. This is the user ID that the CVS client transparently passes to `sshd`. The `cvsrelay` process, in turn, looks up the system password at startup from `prefs.conf` and passes the user-name and encrypted password to CVS. The CVS server, in turn, verifies the delegated credentials with entries in the `CVSROOT/passwd` file.

### 2.5.1.2 Configuring cvsrelay

The `cvsrelay` process acts as the bridge between `sshd` and WANdisco. The `prefs.conf` file contains the configuration parameters for `cvsrelay`. The `prefs.conf` file is first located in the current working directory. If `cvsrelay` does not find it there, it looks for it in the `/etc` directory. If `cvsrelay` still cannot find the file, it logs an error message in UNIX `syslog`.

The bundled `install-cvsrelay` tool automatically generates the `prefs.conf` file.

### Using setup or install-cvsrelay

The following are sample screens depicting how `setup` or `install-cvsrelay` can auto-generate the `prefs.conf` needed by `cvsrelay`.

```
Specify Replicator Host name [localhost] :
You specified localhost, is this correct?[Y|N] [Y] :
Specify Replicator port [2409] :
You specified 2409, is this correct?[Y|N] [Y] :
Specify CVS pserver host name [localhost] : tao
You specified tao, is this correct?[Y|N] [Y] :
Specify CVS pserver port [2401] : 2409
You specified 2409, is this correct?[Y|N] [Y] :
Specify path to the cvs client binary [/usr/bin/cvs] :
You specified /usr/bin/cvs, is this correct?[Y|N] [Y] :
Are CVS Clients using WinCVS or TortoiseCVS? Y/N [N] : Y
You specified Y, is this correct?[Y|N] [Y] :
Enter a valid CVS user on tao [admin0] : user1
You specified user1, is this correct?[Y|N] [Y] :
Enter any valid CVS Root directory on tao [/home/cvs] : /cvsd/admin0/cvs-
root
You specified /cvsd/admin0/cvsroot, is this correct?[Y|N] [Y] :
Enter CVS password :
Creating ../config/prefs-localhost.conf ... [DONE]
**I: Please copy ../config/prefs-localhost.conf to
localhost:/etc/prefs.conf
```

In order to complete the SSH configuration:

- Step 1     Ensure all `cvspserver host:<cvsroot>/CVSROOT/config` files have the entry `SystemAuth=no`.
- Step 2     Copy `../config/passwd-template` file to `cvspserver host:<cvsroot>/CVSROOT/passwd` file and ensure all users added to `passwd` file have the same password.
- Step 3     Ensure SSH daemon (`sshd`) is using `cvsrelay` instead of `cvs`.

### Manual Configuration

The `prefs.conf` syntax is `name=value` pairs. The following parameters can be specified in `prefs.conf` to customize its defaults:

<code>cvs.port</code>	Defaults to 2401. Specifies the CVS replicator port where CVS requests are relayed.

cvcs.host	Defaults to 127.0.0.1 Specifies the IP address (in IPv4 dot notation, not DNS name) of the CVS replicator to forward to. Using the cvcsrelay, one can run <code>sshd</code> and the CVS server on separate hosts. It is not necessary to collocate them.
cvcs.password	Defaults to 117:99:121:32:73:121:60:121 Specifies the octet sequence denoting the system password to pass to the CVS server when delegating the credentials to cvs from <code>sshd</code> . Use the included <code>cvcs-replicator/bin/cvcpasswd</code> program to generate password encoded in WANdisco format for <code>cvcsrelay</code> . This is done to encode the pass phrase generated by the CVS scrambling algorithm when transmitting cleartext passwords on the wire.
relay.buffer.size	Defaults to 4 KBytes Specifies the buffer size used by the relay. Used to tune the performance of the <code>cvcsrelay</code> .

Here is a sample `/etc/prefs.conf` file:

```
$ cat /etc/prefs.conf
cvcs.port=2401
cvcs.host=192.168.1.20
cvcs.password=117:99:121:32:73:121:60:121
```

### TortoiseCVS, WinCVS GUI Clients

If you use one of the many popular GUI clients with `cvcsrelay`, you may need to patch the `cvcsrelay` installation to make it work. For example, when using Tortoise and WinCVS, you may see the following error message:

```
warning: unrecognized response `Please run install-cvcsrelay for this
client' from cvs server
```

If you see the above message, then you need to run the bundled `install-cvcsrelay` utility (in `cvcs-replicator/bin`).

The `install-cvcsrelay` utility prompts you for the fully qualified path to the cvs server executable. It then attempts to create a patch specific to the version of cvs server you are using. If you install a different version of cvs server at a later date, be sure to re-run `install-cvcsrelay`.

```
> cd cvcs-replicator/bin
> pwd
cvcs-replicator/bin
> ./install-cvcsrelay
```

Once `install-cvcsrelay` has patched the `prefs.conf` file, you can then start using Tortoise and WinCVS clients.

## 2.5.2 pserver Protocol

### 2.5.2.1 Configuring (x)inetd Limits

For CVS MultiSite, the demands on (x)inetd and its optimal configuration differ from standard CVS.

When clients access the CVS server directly, each client typically connects to the CVS server from a different address. In contrast, when a client accesses WANdisco, WANdisco in turn connects to the CVS server on behalf of the client. Thus, all connections to the CVS server originate from the same IP address. To address this, we recommend an appropriate increase of the per-source connections-per-second limit. For example, in `xinetd.conf`,

```
defaults
{
....
per_source = UNLIMITED
....
}
```

When a WANdisco instance recovers from a crash, it goes through both a local recovery process, where CVS transactions are replayed from its log, and a distributed recovery process, where CVS transactions are learned from remote nodes and replayed. During this process, the transaction rate on the CVS server can be much higher than normal. To support this higher transaction rate, WANdisco recommends an appropriate increase of the number of servers that can be simultaneously active, and the maximum allowed connection rate. For example, in `xinetd.conf`,

```
defaults
{
....
instances = UNLIMITED
cps = 10000 30
....
}
```

## 2.6 Changing CVS Port on Unix Flavor

To change the CVS port on any Unix flavor platform, follow these steps.

Prerequisites:

- CVS is installed
- `xinetd` is installed

Change the CVS port:

Step 1 Modify the `/etc/services` file.

Step 2 Modify the `xinetd` file for CVS.

Step 3 Restart `xinetd`.

Change the `/etc/services` file:

Step 1 Change to the root user, for example: `su root`.

Step 2 Edit the `/etc/services` file: `vi /etc/services`. In the line

```
cvspserver 2401/tcp
```

change the port number to the new port CVS is to run on, typically

```
cvspserver 2402/tcp
```

Step 3 Save the file.

Modify the `xinetd` file for CVS:

Step 1 Change to the root user, for example: `su root`.

Step 2 Edit the `cvspserver` file, located in the directory: `/etc/xinetd.d`.

Modify the line `port = [current port]`.

For a typical installation, the modification changes the port number to 2402.

Step 3 Save the file.

Restart `xinetd`:

Step 1 Change to the root user, for example: `su root`.

Step 2 Execute:

```
/sbin/service xinetd restart
```

## 2.7 Changing CVS Port on CVSNT

On the CVS server, change the value in the CVS Server Port field in the Server Settings tab of the CVS NT Server window. The CVS NT Server window is available at `Start > Control Panel > CVS NT Server`.

## 3 Installation

---

### 3.1 First Time Installation of First Site

You must run the installation program at the first site in the replication group. Ensure that CVS is running.

- Step 1 Save the cvsrep.tar.gz file.
- Step 2 For Windows, create a directory, and unzip the file in that directory. For other platforms, untar the file. The uncompressed file produces a directory, cvs-replicator.
- Step 3 Copy the license key file to the cvs-replicator/config directory.
- Step 4 At the command prompt (or editor), go to cvs-replicator/bin.
- Step 5 Type
- ```
perl setup
```
- The last line of text returned contains a WANdisco URL.
- Step 6 Copy the URL returned in the last step and paste it into a browser. The MultiSite Welcome page appears.

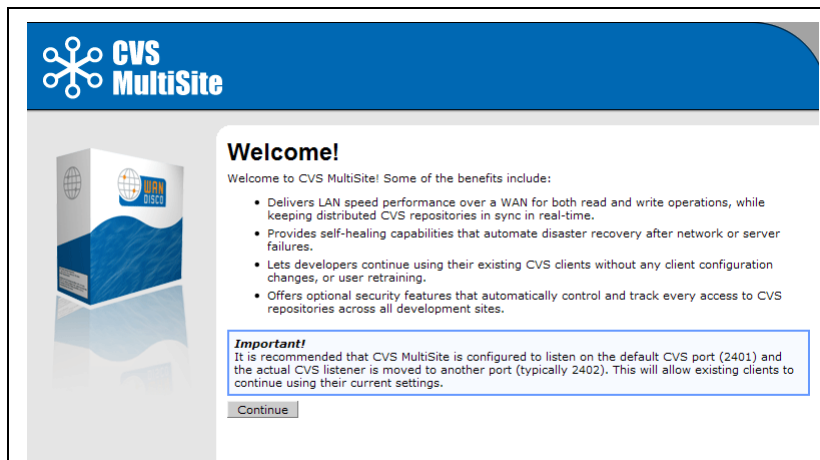

- Step 7 Click **Continue** at the Welcome text.

- Step 8 Read the User Licence Agreement. You must agree to the terms to continue.
- Step 9 The Current Configuration page appears. After reading it, click **Next**.

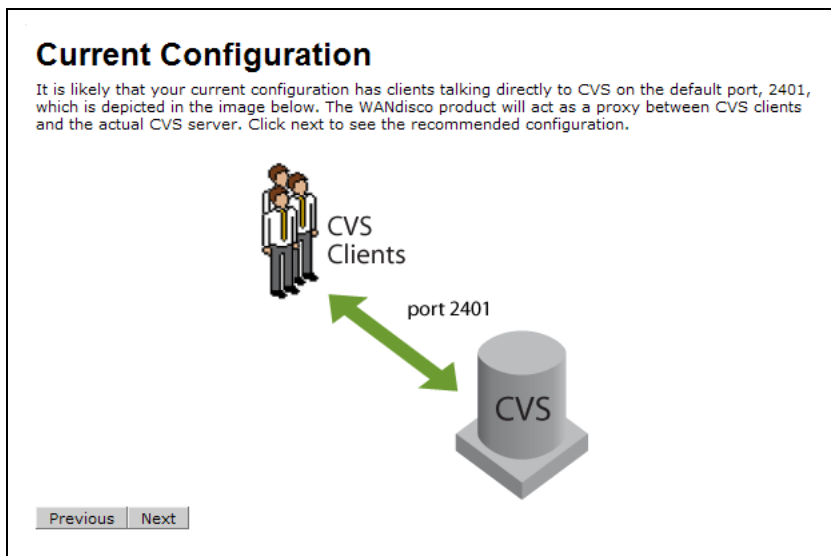

- Step 10 Read about the recommended configuration. See [6.12, Using CVS admin -l to Lock Parts of CVS Repository](#).
- Step 11 Click **Next**. The CVS MultiSite Settings page appears.

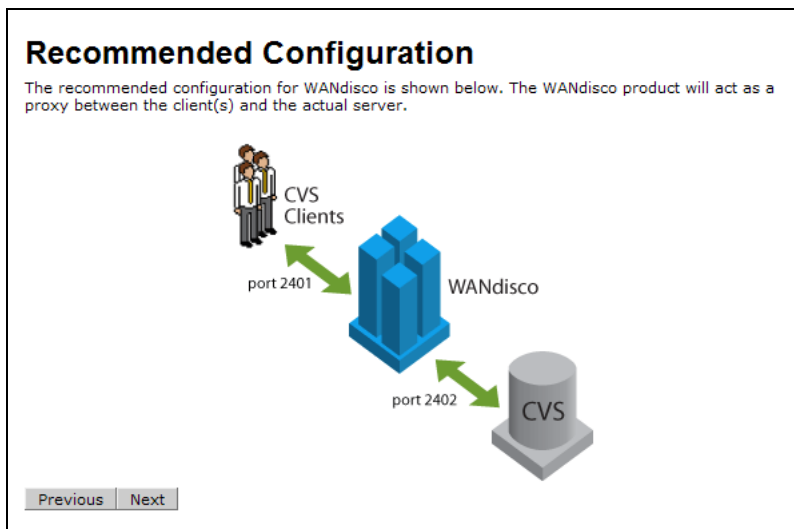

### 3.1.1 Specifying MultiSite Settings

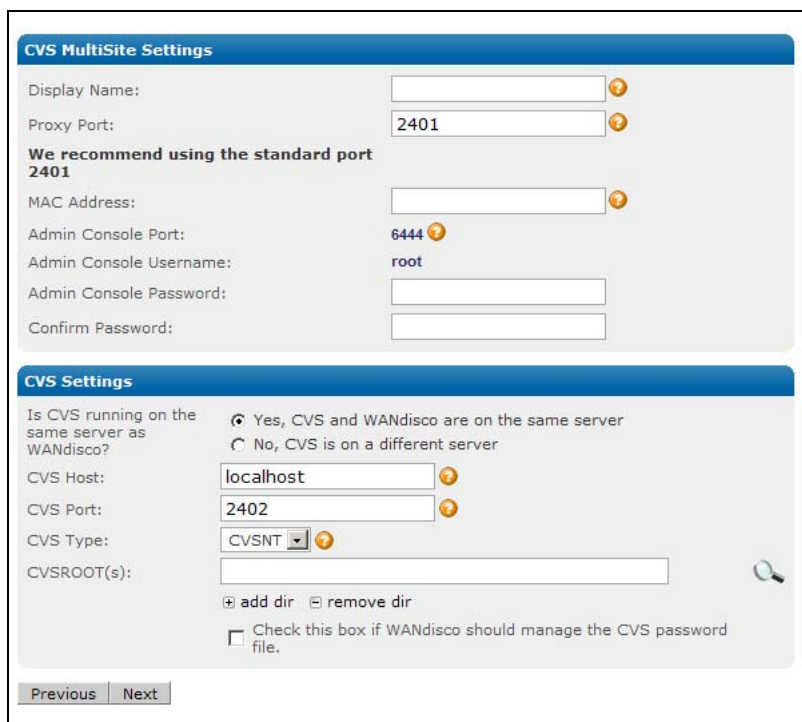

The screenshot shows two configuration panels. The top panel, titled "CVS MultiSite Settings", includes fields for "Display Name", "Proxy Port" (set to 2401), "MAC Address", "Admin Console Port" (set to 6444), "Admin Console Username" (set to root), "Admin Console Password", and "Confirm Password". The bottom panel, titled "CVS Settings", includes a radio button selection for "Is CVS running on the same server as WANdisco?" (selected as "Yes"), fields for "CVS Host" (localhost), "CVS Port" (2402), a "CVS Type" dropdown (set to CVSNT), and a "CVSROOT(s)" field with "add dir" and "remove dir" buttons. A checkbox at the bottom of the second panel is labeled "Check this box if WANdisco should manage the CVS password file." Navigation buttons for "Previous" and "Next" are at the bottom left.

Step 12 In the Display Name field, enter a name for this first site in the replication group.

Step 13 In the Proxy Port field, enter a port number. WANdisco recommends using 2401, as this is the standard pserver port number.

Step 14 Enter the MAC address. To find the MAC address, go to the machine's command prompt. For Unix, type

```
ifconfig
```

For Windows, type

```
ipconfig /all
```

The MAC address is the physical address.

For example, on a Windows machine, the output would look like:

```
Physical Address. . . . . : 00-1A-A0-36-53-3C
Dhcp Enabled. . . . . : Yes
Autoconfiguration Enabled . . . . : Yes
IP Address. . . . . : 192.168.1.124
Subnet Mask . . . . . : 255.224.255.0
```



- Step 19 Enter the CVS protocol. If you select CVS, the SSH Access required? checkbox appears.
- Step 20 Define the CVS root or roots. Browse to the file locations.
- Step 21 If you have CVS and WANdisco on the same server, and you want WANdisco to manage the CVS password file, check the checkbox and then browse to the location of the CVS password file.
- Step 22 Click **Next**. The Checklist appears.

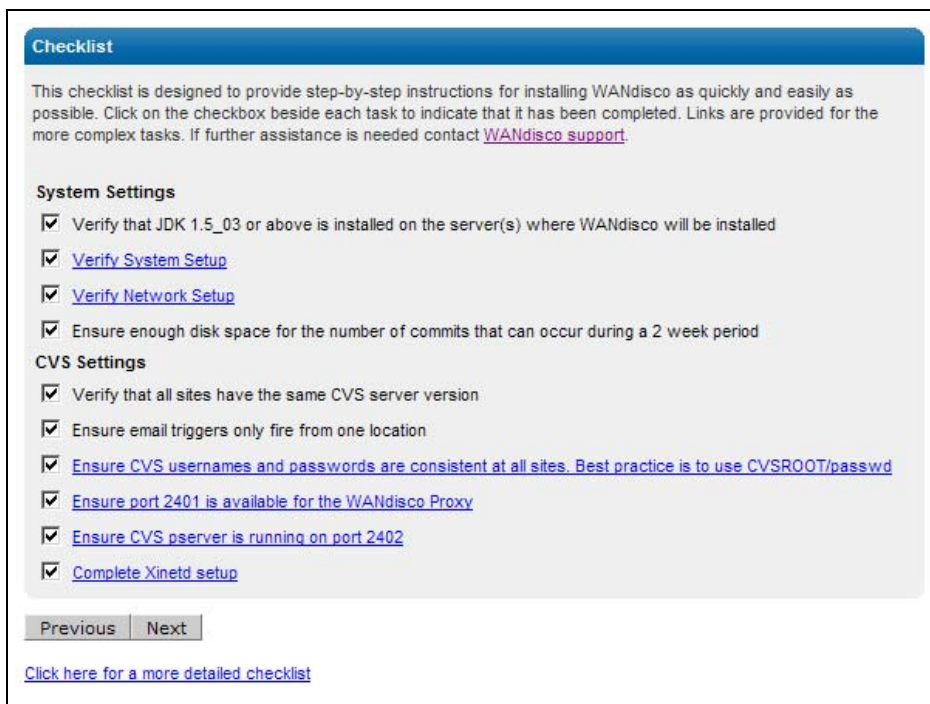

- Step 23 Read over each item, and check each checkbox. You must be logged in to the WANdisco support site for the links to work.
- Step 24 Click **Next**. The Verify Setup page appears.

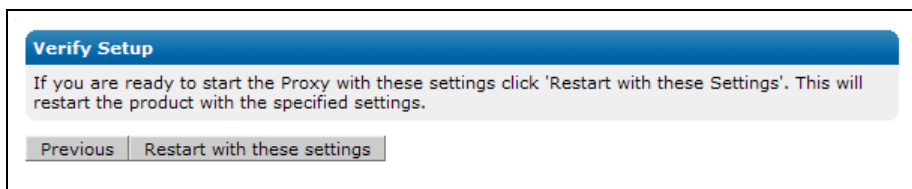

### 3.1.3 Initializing First Site

Step 25 Click **Restart with these settings**. The installer configures and restarts your server.

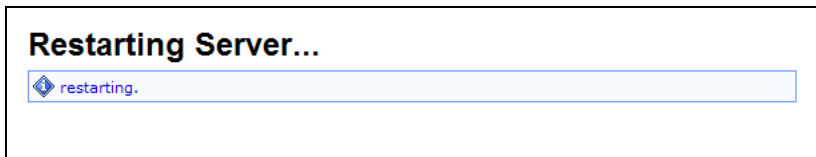

The installer creates a directory called wandisco that has the following directories inside.

| DIRECTORY | CONTENTS                                                                                                                                                    |
|-----------|-------------------------------------------------------------------------------------------------------------------------------------------------------------|
| bin       | Contains scripts like <code>cvsreplicator</code> , <code>shutdown</code>                                                                                    |
| config    | Contains the <code>[replicator]/config/prefs.xml</code> file used to configure MultiSite.                                                                   |
| lib       | Contains the <code>jar</code> files and DLLs that are required to run the product.                                                                          |
| docs      | Contains this <i>Administration Guide</i> in PDF format.                                                                                                    |
| logs      | Contains the pid file, log files and other temporary files. WANdisco Multi-Site's log file is named <code>ProxyServer-prefs.log</code> .                    |
| systemdb  | Contains the system database with its transaction journal. <b>Warning:</b> Deleting or modifying files from systemdb will likely corrupt your installation. |

### 3.1.4 Setting the WANdisco Run-As User

You now have MultiSite's Admin Console running in your browser. If WANdisco is controlling the password file, perform the next step.

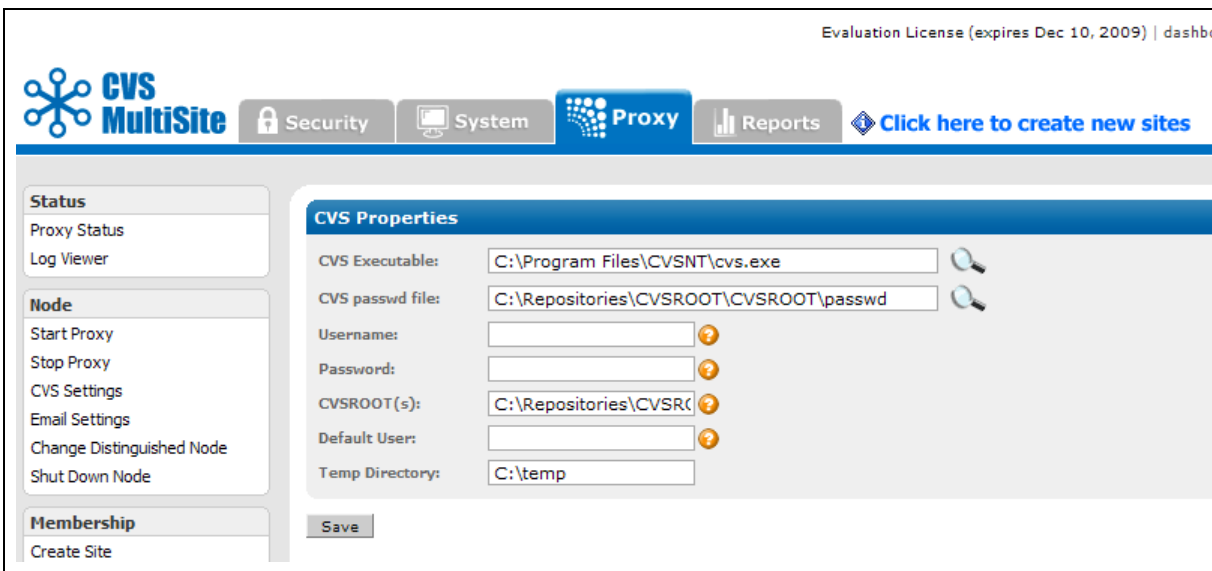

The screenshot shows the CVS MultiSite Admin Console interface. At the top right, it says "Evaluation License (expires Dec 10, 2009) | dashb...". The navigation menu includes "Security", "System", "Proxy" (which is active), and "Reports". There is a link "Click here to create new sites". On the left, there are sections for "Status" (Proxy Status, Log Viewer), "Node" (Start Proxy, Stop Proxy, CVS Settings, Email Settings, Change Distinguished Node, Shut Down Node), and "Membership" (Create Site). The main content area is titled "CVS Properties" and contains the following fields:

- CVS Executable:
- CVS passwd file:
- Username:
- Password:
- CVSROOT(s):
- Default User:
- Temp Directory:

A "Save" button is located at the bottom left of the form.

- Step 26 Define a run-as, or default username for WANdisco. Go to the Proxy page, and click **CVS Settings**. In the **Default User** field, enter in the run-as, or default, username. This setting gets replicated throughout the group.

If your password file is in version control, also specify a directory in the **Temp Directory** field so WANdisco can use it as a sandbox for the password file.

The run-as user is a standard CVS concept, where all CVS clients use the same run-as user. You should use the same run-as user in WANdisco as you used before. The password file syntax is usually `user-name:encrypted password:run-as username`.

If you ever change the run-as user on this page, you must edit the password file to update the entries to the new run-as, or default user.

### 3.1.5 Validating the Installation

You must perform a few steps to ensure WANdisco is properly installed and communicating with CVS.

Step 27 Create a user in WANdisco. If you previously chose not to have WANdisco update the password file, you must update it for the new user.

Step 28 From a client, log in to CVS as that user.

**NOTE:**

---

Do not log in from the server where you installed WANdisco.

---

Step 29 Check out a file, modify it, and check it back in.

Step 30 Go to the WANdisco Admin Console's Dashboard to view the transaction.

click on **dashboard**

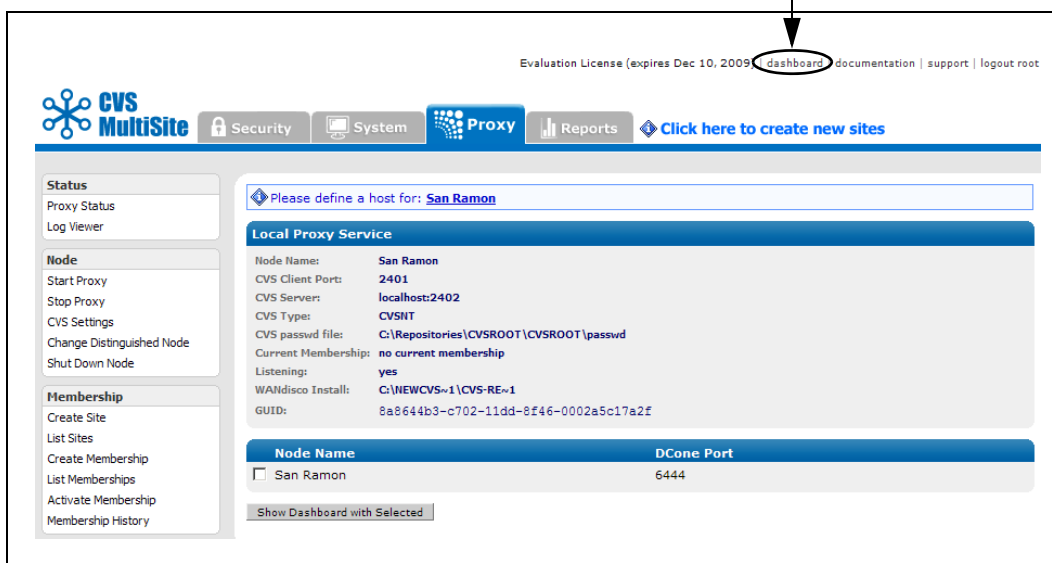

## 3.2 Specifying Subsequent Sites

Now that you have verified the first site's installation, you can continue to deploy MultiSite to other sites.

**NOTE:**

The installer packages whatever users are in the first site for distribution to the other sites. You are also given the option (in a few more steps) of packaging the CVS repository for the other sites.



Step 31 Click on the link **Click here to create new sites**. The Site Properties page appears.

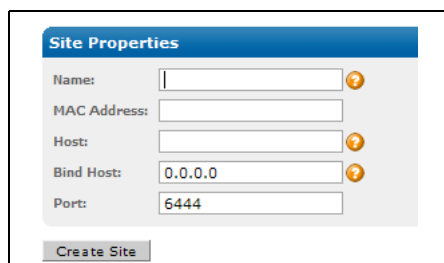

Step 32 Enter a name, the MAC address, host name, bind host and WANdisco port number for the site.

Step 33 Click **Create Site**. A page appears containing information for the first site and the site you just created.

You must specify the first site's IP address (define the host).

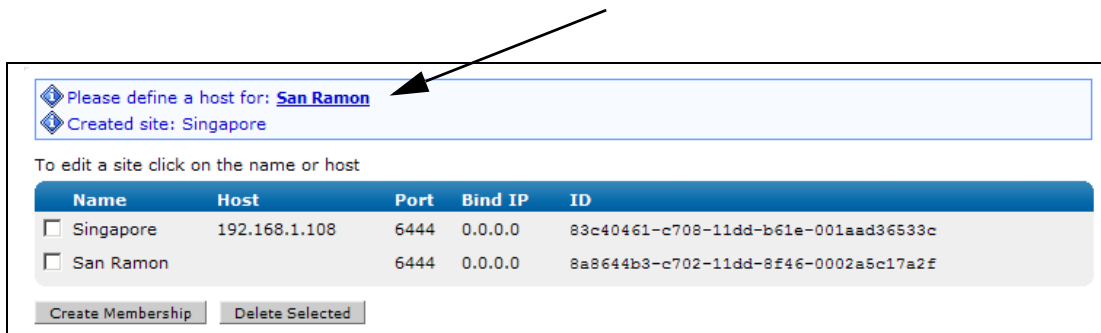

Step 34 Define a host for your first site. Click the site name, and enter that site's IP address.

Step 35 Repeat steps 31 through 33 for each site in your replication group.

### 3.2.1 Creating the Replication Group

Step 36 To create the replication group, click **Create Membership**. The Membership Properties page appears.

Note that the first site is the distinguished node.

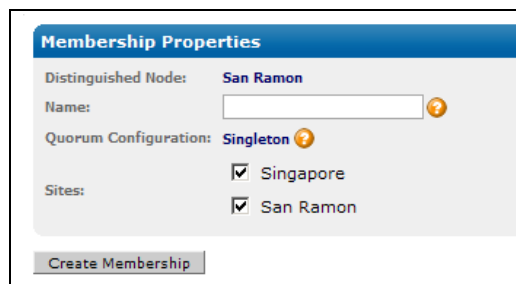

Step 37 Enter a name for the replication group.

Step 38 Select the type of quorum for the replication group. For a discussion of quorum, see section 1.1.1.1, [Singleton Quorum](#). Note that evaluation licenses only allow singleton quorum.

Step 39 Check the sites you wish to include in the membership.

Step 40 Click **Create Membership**. A page appears, listing the replication group name and other information.

| Name                                      | Quorum    | Distinguished Node                             | Sites                | Actions                  |
|-------------------------------------------|-----------|------------------------------------------------|----------------------|--------------------------|
| <input type="checkbox"/> California Group | Singleton | San Ramon 8a8644b3-c702-11dd-8f46-0002a5c17a2f | Singapore, San Ramon | <a href="#">activate</a> |

Delete Selected

Step 41 Click **activate**. The Activate Membership page appears.

Activating a membership will stop all sites and temporarily prevent write transactions

### Activate Membership

Activating a membership will cause the current Membership to become inactive (including all the Sites that are in the Membership). It will be replaced with Sites defined in the selected Membership.

CVSROOT(s): C:\Repositories\CVSROOT ?

Proxy Directory: C:\NEWCVS~1\CVS-RE~1

Package Repository:  Yes  
 No, I will synchronize the repositories manually

Temp Directory:  

The temp directory is used to create an installer for the new site(s) and also create a snapshot of the current repository.

Activate Membership:  

### 3.2.2 Packaging the CVS Repository?

- Step 42 Specify whether you want the installer to package the CVS repository for the other sites.
- Step 43 Specify a temporary directory where you want the installer to put the compressed installation files for the other sites.
- Step 44 Select the replication group to activate.
- Step 45 Click **Prepare Membership**. The Confirm Sites are Shut Down page appears.

◆ Synchronized stop completed  
◆ New Membership message sent to all nodes and persisted to local node

**Confirm Sites are Shutdown**

All site(s) in the previous membership have been issued a shutdown request. Please make sure that all other site(s) are shutdown before continuing. Once the other sites have shutdown, click the button below to trigger a restart at this site which will activate the membership.

Once this site has restarted:

1. Manually start the sites that are part of the previous membership AND the new membership
2. Follow the steps on the next screen to activate sites that are not part of the previous membership

Restart Proxy

The first site is stopped, and the membership is activated.

### 3.2.3 Packaging Subsequent Sites

Step 46 Click **Restart Proxy**. The Activating Membership page appears.

Site  
Packager

Packager

Execution time: 0:24

◆ Packaging complete! Restarting proxy..  
◆ Redirecting to proxy...

**Activating Membership**

|                            |                         |
|----------------------------|-------------------------|
| Temp dir:                  | C:\temp\wandisco        |
| Repository Dir 1:          | C:\Repositories\CVSROOT |
| Repository Archive Size 1: | 30 Kilobytes            |
| Site Singapore:            | 14,006,339 bytes        |

```

1. ----- starting packager
2. using directory: C:\temp\wandisco
3. using JAVA_HOME from environment: C:\jdk16
4. platform: Windows NT
5. REPLICATOR_PARENT_DIR: C:\NEWCVS-1
6.
7. starting MiniWeb: "C:\jdk16\bin/java" -cp miniweb.jar wandisco.net.MiniWeb
8. REPLICATOR_DIR_NAME: CVS-RE-1
9. REPOSITORY_DIR(s): C:\Repositories\CVSROOT,
10. Running packager...
11. copying replicator logs to C:\temp\wandisco/logs
12. copying files from C:\NEWCVS-1\CVS-RE-1/logs to C:\temp\wandisco/logs
13. setting execute permission for setup-site file(s)
14. changed permissions on 1 files
          
```

Then the Adding Sites page displays, listing the .jar files created for each site. The installer creates a file for the first site, even though the first site is already configured.

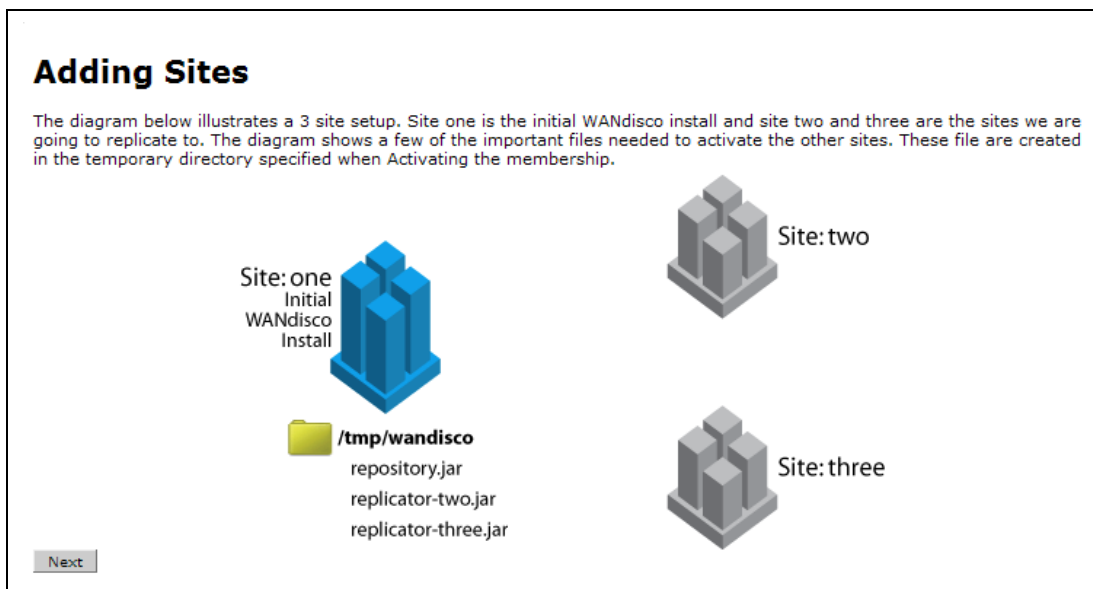

Step 47 At the Adding Sites page, click **Next**.

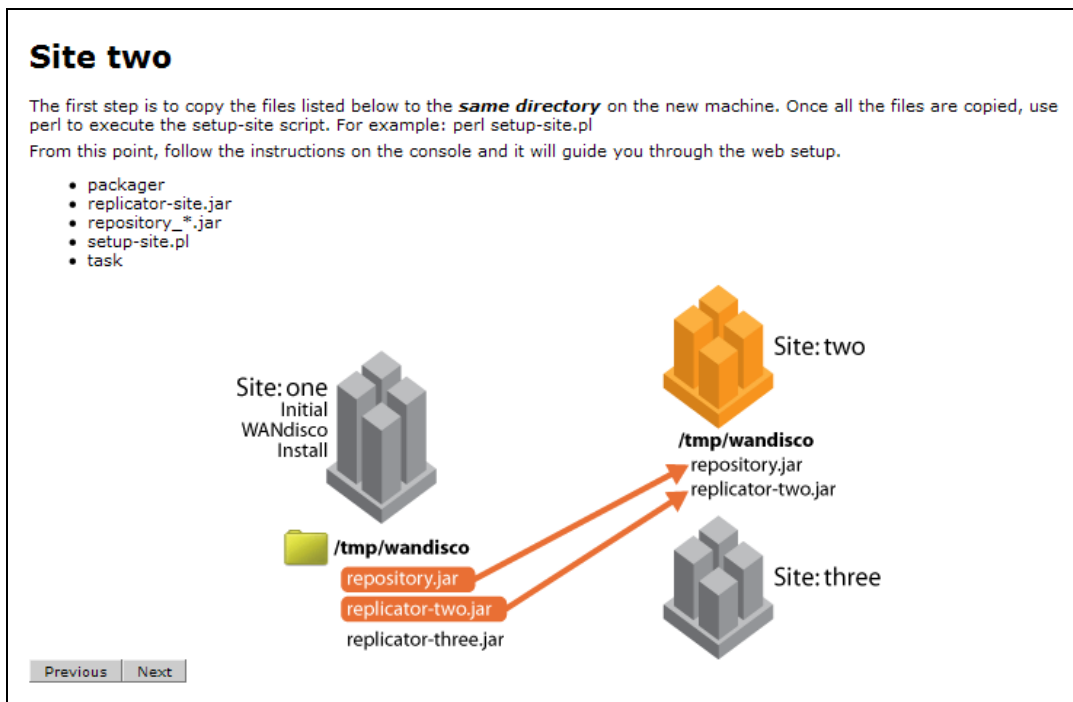

### 3.2.4 At Each Additional Site

- Step 48 Make the same `WANdisco` directory (specified in step 43) at each of the new sites.
- Step 49 Copy the specified files to each site. The files are located at the first site, in the `WANdisco` directory. If you are handling the repository separately, ignore the repository `.jar` file. For each site, copy:

|                                          |                                                                                  |
|------------------------------------------|----------------------------------------------------------------------------------|
| <code>packager</code>                    | use same file for each site                                                      |
| <code>replicator-&lt;site&gt;.jar</code> | use unique file for each site                                                    |
| <code>repository_*.jar</code>            | only available if WANdisco packages the repository. Use same file for each site. |
| <code>setup-&lt;site&gt;.pl</code>       | use unique file for each site                                                    |
| <code>task</code>                        | use same file for each site                                                      |

### 3.2.5 Releasing First Site to Users

- Step 50 You can now release the first site to CVS users. As a member of the replication group, any client transactions that modify the repository are replicated at the other sites in the replication group when those sites come up.

## 3.3 Activating Subsequent Sites

- Step 51 Start the installer at a new site. At the command prompt, type

```
perl setup-<site name>.pl
```

The output returns a URL in the last few lines.

- Step 52 Copy the URL into a browser. The Welcome Back! page appears.

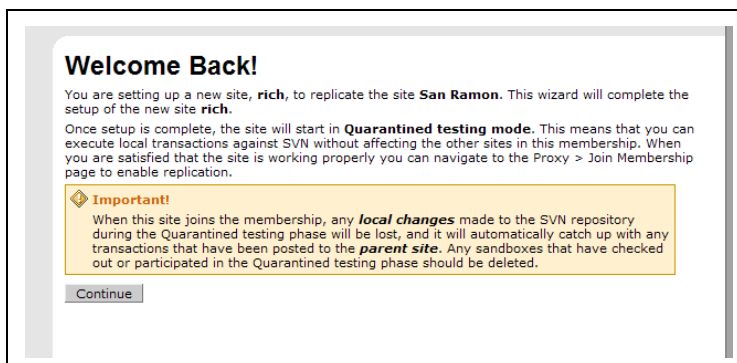

- Step 53 Click **Continue**. The License Agreement page appears. You must accept the agreement to continue.
- Step 54 The Checklist page appears for this site. Read through the checklist. You should already have prepared the site for WANdisco, but do so now if necessary. Check all the boxes in the Checklist, and click **Next**. The Verify Setup page displays.
- Step 55 If everything looks ok, click **Restart with these settings**.

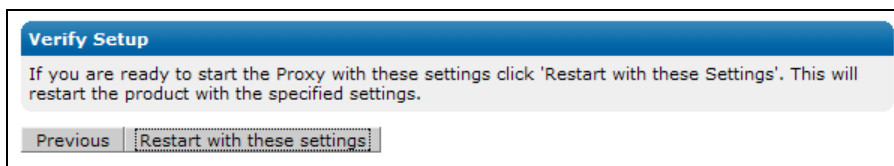

When the server restarts, the Admin Console appears for the new site.

### 3.3.1 New Site Quarantined

MultiSite is up at the new site. Note that the site is quarantined until you verify the validity of the installation. After you verify the installation, if you elected to have WANdisco copy the repository, it will be replaced. If you are handling the repository yourself, you will resynch it.

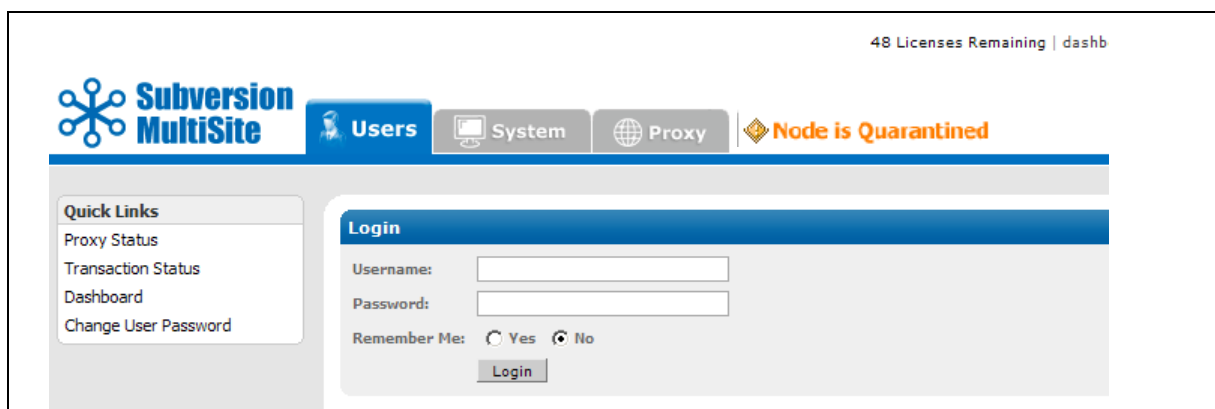

### 3.3.1.1 Verifying the Installation

Step 56 Log in as root. The following message appears.

 This node is Quarantined. It is operating as a single location without replication. Execute as many transactions as needed to verify this node is operational. Then click [Join Membership](#) to begin replication.

Step 57 Test this installation. Perform, at a minimum, a commit transaction and a create user command. (Create User is in the User tab.) Verify the user was created in CVS as well.

Step 58 If you are copying the repository yourself, resynch it. If you had WANdisco copy the repository, it reverts to the copied state.

### 3.3.1.2 Taking a Site Out of Quarantine

Step 59 Join this site to the replication group membership. Click **Join Membership** in the Proxy tab. The sites in the membership come to a synchronized stop.



The screenshot shows the CVS MultiSite web interface. At the top right, it says "Evaluation License (expires Dec 10, 2009) | dashboard | documentation | support | logout root". The navigation bar includes "Security", "System", "Proxy", and "Reports". A warning icon and "Node is Quarantined" message are visible in the top right of the main content area.

The main content area is divided into a left sidebar and a main panel. The sidebar has sections for "Status" (Proxy Status, Log Viewer), "Node" (Start Proxy, Stop Proxy, CVS Settings, Change Distinguished Node, Shut Down Node), and "Membership" (List Sites, Membership History).

The main panel displays a yellow warning box with the same text as in Step 56. Below it is the "Local Proxy Service" configuration for the "Singapore" node:

- Node Name: Singapore
- CVS Client Port: 2401
- CVS Server: localhost:2402
- CVS Type: CVSNT
- CVS passwd file: C:\Repositories\CVSROOT\CVSROOT\passwd
- Current Membership: California Group
- Listening: yes
- WANdisco Install: C:\NEWCVS~1\CVS-RE~1
- GUID: 83c40461-c708-11dd-b61e-001aad36533c

Below the configuration is a table with columns "Node Name" and "DCone Port":

| Node Name                          | DCone Port |
|------------------------------------|------------|
| <input type="checkbox"/> Singapore | 6444       |

At the bottom of the table is a button labeled "Show Dashboard with Selected".

Step 60 Click **Resume**. WANdisco joins this site to the replication group, catching it up on any transactions that occurred within the replication group. This site can be released to CVS users while you bring up any other sites.

**Local Proxy Service**

|                     |                                        |
|---------------------|----------------------------------------|
| Node Name:          | Singapore                              |
| CVS Client Port:    | 2401                                   |
| CVS Server:         | localhost:2402                         |
| CVS Type:           | CVSNT                                  |
| CVS passwd file:    | C:\Repositories\CVSROOT\CVSROOT\passwd |
| Current Membership: | California Group                       |

Listening: All proxies are currently stopped. In this mode, read transactions can take place but not write transactions. Clicking resume below will trigger a restart at all nodes.

|                   |                                      |
|-------------------|--------------------------------------|
| WANdisco Install: | C:\NEWCVS~1\CVS-RE~1                 |
| GUID:             | 83c40461-c708-11dd-b61e-001aad36533c |

| Node Name                          | DCone Port |
|------------------------------------|------------|
| <input type="checkbox"/> San Ramon | 6444       |
| <input type="checkbox"/> Singapore | 6444       |

Step 61 Repeat steps 51 through 60 for each additional site.

You now have successfully installed CVS MultiSite.

CVS MultiSite starts in watchdog mode by default, which restarts MultiSite if it goes down. You may want to set up the watchdog email now, so that an administrator receives an email from WANdisco if the MultiSite goes down. Note that the watchdog email setting is per site. See [7.5, About Watchdog Mode](#).

## 3.4 Installing Upgrades

**NOTES:**

---

This procedure involves taking CVS offline. Please follow your company procedures about notifying CVS users of down time.

---

### 3.4.1 Stop WANdisco

- Step 1 After notifying CVS users of the downtime, stop CVS MultiSite. Perform a synchronized stop of all sites. See [6.3, Performing a Synchronized Stop](#).
- Step 2 Shut down each site. Go to each site's Proxy page, and click **Shut Down Node**.

### 3.4.2 Export WANdisco Data

- Step 3 On the System page, select **Export Settings**. These settings include user information. You only need to do this at one site, since the files at other sites are identical.

### 3.4.3 Preparing the Sites

At each site:

- Step 4 Copy the entire `cvs-replicator` directory to a backup location.
- Step 5 On the original install node, zip the `config` directory.
- Step 6 Delete the `systemdb` directory.
- Step 7 In the `cvs-replicator/config` directory, delete these directories:
  - `membership`
  - `security`
  - `passwd`

### 3.4.4 At the Install Site

- Step 8 Save the `cvsrep.tar.gz` file and extract it to a new directory, for example `new/cvs-replicator`.
- Step 9 Unzip or untar the file.
- Step 10 Verify the md5 checksum. For Unix, type
  - `md5sum <filename>`
- Step 11 Copy the file `new/cvs-replicator/lib/cvs-replicator.jar` to the `cvs-replicator/lib` directory.

- Step 12 Copy the entire directory `new/cvs-replicator/lib/html` to `cvs-replicator/lib/html`.
- Step 13 Copy the licence key file to `cvs-replicator/config` directory.

### 3.4.5 Running the Install Program

- Step 14 Run this command on the original install site. The install program automatically populates all previous configuration information.

```
cvs-replicator/bin/setup
```

The Setup page appears.

- Step 15 Click **Next** to continue.
- Step 16 Make changes as needed. The Admin Console appears.

### 3.4.6 Importing WANdisco Data

- Step 17 Import WANdisco data. On the System page, select **Import Settings**. Import the file you exported in step 3.
- Step 18 Perform a synchronized stop.
- Step 19 For additional sites, refer to section [3.2, Specifying Subsequent Sites](#).

You have successfully installed a CVS MultiSite upgrade.

## 4 Using the Admin Console

The Admin Console is a simple interface that allows you to monitor and perform administrative tasks for CVS MultiSite.

You can run the Admin Console from any site. The login is `root`. Passwords are the same for all sites, and are set during installation.

To access the Admin console, all you need is the IP address of any site and the WANdisco port number.

### 4.1 Starting the Admin Console

To start the Admin Console, in a browser's address bar, type

*http://<IP address>:<WANdisco port number>*

The Admin Console's Home page appears.

MultiSite's Admin Console has four pages, identified by their tabs: the Security, System, Proxy and Reports pages.

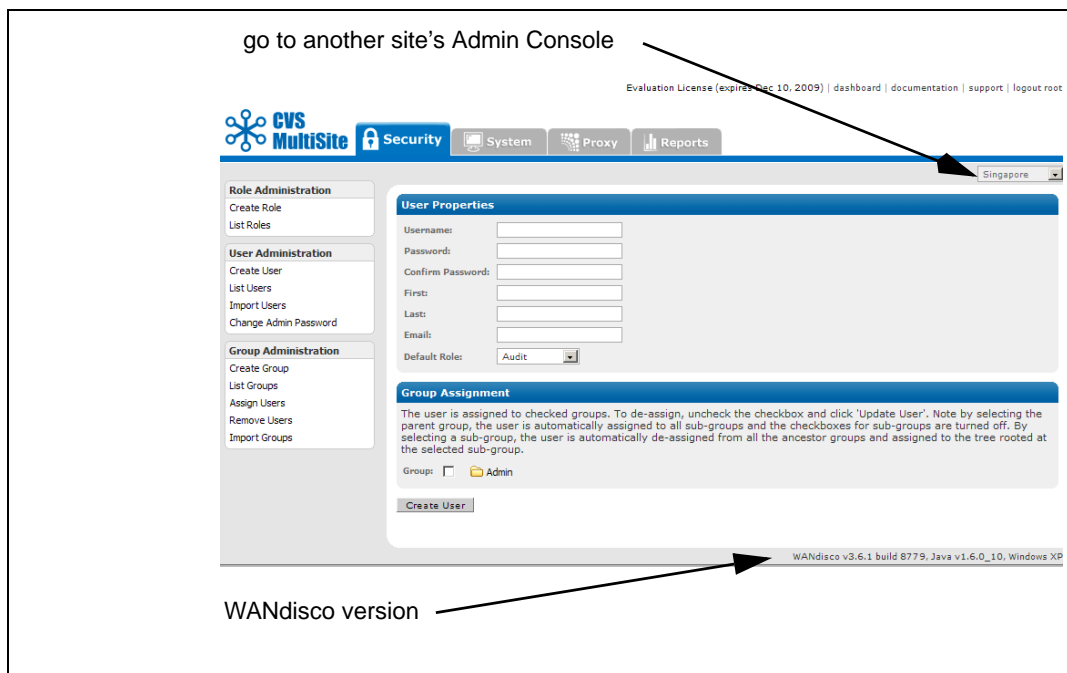

## 4.2 The Security Page

The Security page offers user administration commands. Please note that the Groups and Roles features are inactive for CVS MultiSite.

### 4.2.1 Left Side Menu

|                             |                                                                                                                                                              |
|-----------------------------|--------------------------------------------------------------------------------------------------------------------------------------------------------------|
| <b>Role Administration</b>  | Inactive feature                                                                                                                                             |
| <b>User Administration</b>  |                                                                                                                                                              |
| Create User                 | Create any CVS user.                                                                                                                                         |
| Username                    | Enter in the CVS user's username.                                                                                                                            |
| Password                    | Enter the user's password.                                                                                                                                   |
| Confirm Password            | Confirm the password.                                                                                                                                        |
| First Name                  | Enter the user's first name.                                                                                                                                 |
| Last Name                   | Enter the user's last name.                                                                                                                                  |
| Email                       | Enter the users email address.                                                                                                                               |
| List Users                  | This command displays all users.                                                                                                                             |
| Import Users                | You can import an existing list of users. The import file must be a comma delimited text file, of the format <code>userid,last-name,firstname,email</code> . |
| Change Admin Password       | You can change the WANdisco Admin password <i>for this site only</i> with this command. See <a href="#">6.9.1, Changing the Password</a> .                   |
| <b>Group Administration</b> | Inactive feature                                                                                                                                             |

## 4.3 The System Page

The System page offers several commands and utilities for the MultiSite replication group.

### 4.3.1 Left Side Menu

|                       |                                                         |
|-----------------------|---------------------------------------------------------|
| <b>System</b>         |                                                         |
| Log Viewer            |                                                         |
| ProxyServer-prefs.log | WANdisco log file.                                      |
| web proxy.log         | A log from the installation.                            |
| <b>Show Log</b>       | Click this to display a log in the Dashboard.           |
| Transaction Status    | You can search for a specific transaction.              |
| Transaction Number    | Enter in the transaction number.                        |
| Site Submitted From   | Select the site where the transaction originated.       |
| <b>Show Status</b>    | Click this after entering the data in the above fields. |
| Named Sequences       | Used internally.                                        |
| Dynamic Prefs         | Used internally.                                        |

|                       |                                                                                                                                                                                                                        |
|-----------------------|------------------------------------------------------------------------------------------------------------------------------------------------------------------------------------------------------------------------|
| Log Level             | WANdisco uses one transaction log, and the default level is <b>info</b> . The levels vary from <b>severe</b> , where you get only the most severe warnings, to <b>finest</b> , which logs every action.                |
| Free Memory           | This command frees the memory (GB stands for garbage collection) for the current site. The command occurs when you click on this menu selection. The display shows information on the command that was just performed. |
| max mem used by JVM   | the maximum memory that JVM can use on the current site                                                                                                                                                                |
| free memory before GC | the amount of free memory before you ran this command                                                                                                                                                                  |
| free memory after GC  | the amount of free memory after you ran this command                                                                                                                                                                   |
| memory freed          | the total amount of memory freed at the command's completion                                                                                                                                                           |
| Dashboard             | offers another way to get to the Dashboard. The Dashboard is discussed in detail in section <a href="#">4.6, The Dashboard</a> .                                                                                       |
| Backup                |                                                                                                                                                                                                                        |
| Import Settings       | This command allows you to import WANdisco settings, including all users.                                                                                                                                              |
| Export Settings       | This command allows you to export WANdisco settings, including all users, for later importation into a WANdisco product.                                                                                               |

## 4.4 The Proxy Page

**Local Proxy Service**

Node Name: **San Ramon**  
 CVS Client Port: **2401**  
 CVS Server: **localhost:2402**  
 CVS Type: **CVSNIT**  
 CVS passwd file: **C:\Repositories\CVSROOT\CVSROOT\passwd**  
 Current Membership: **California Group**  
 Listening: **yes**  
 WANdisco Install: **C:\NEWCVS~1\CVS-RE~1**  
 GUID: **8a8644b3-c702-11dd-8f46-0002a5c17a2f**

| Node Name                          | DCone Port |
|------------------------------------|------------|
| <input type="checkbox"/> Singapore | 6444       |
| <input type="checkbox"/> San Ramon | 6444       |

Show Dashboard with Selected

### 4.4.1 Left Side Menu

#### Status

- Proxy Status This command displays the site's status in the page's main area.
- Log Viewer You can view the `ProxyServer-prefs.log` file in the Dashboard.

#### Proxy

- Start Proxy This starts WANdisco at this site.
- Stop Proxy This stops WANdisco at this site. See [6.1.1, Temporarily Disabling CVS Access at Selected Sites](#).
- Stop this proxy only This stops WANdisco at this site. See [6.1.1, Temporarily Disabling CVS Access at Selected Sites](#).
- Synchronized stop of all proxies A synchronized stop stops WANdisco at all sites, and replication is suspended. See [6.3, Performing a Synchronized Stop](#).

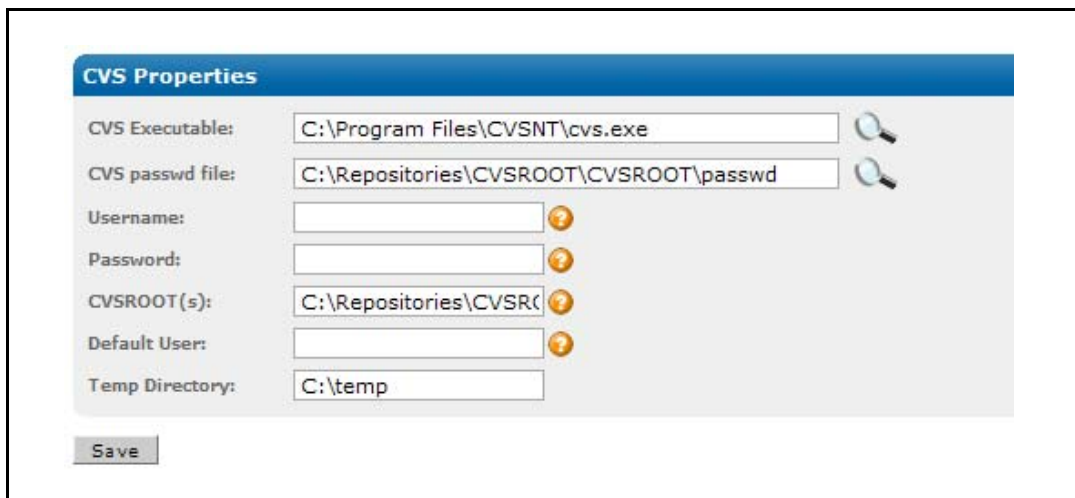

**CVS Settings**

- CVS Executable Browse to the CVS executable file.
- CVS passwd file The password file path specified at installation is listed.
- Username For WANdisco access to CVS server when WANdisco is on a different server than CVS.
- Password For WANdisco access to CVS server when WANdisco is on a different server than CVS.
- CVSROOT The CVSROOT file path specified at installation is listed.
- Default User Enter in a default username. WANdisco passes all CVS client transactions to the CVS server using this username.
- Temp Directory The temp directory specified at installation is listed.
- Save** Save any changes.

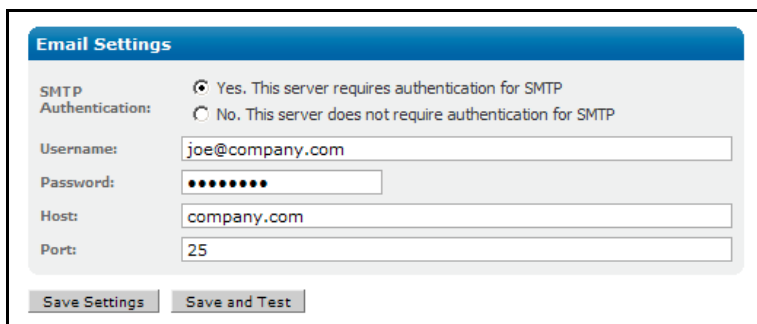

**Email Settings**

- SMTP Authentication Set the email settings for the watchdog contact. You have to set the email in watchdog also. See [7.8, About the Watchdog Mode](#).
- Username Select whether you need SMTP Authorization. For authentication, enter a valid username.

|                      |                                                                                 |
|----------------------|---------------------------------------------------------------------------------|
| Password             | For authentication: enter a valid password.                                     |
| Host                 | Enter the email host.                                                           |
| Port                 | Enter the email port number.                                                    |
| <b>Save Settings</b> | Save any changes.                                                               |
| <b>Save and Test</b> | Save any changes, and run an email test. Selecting this displays the test page. |

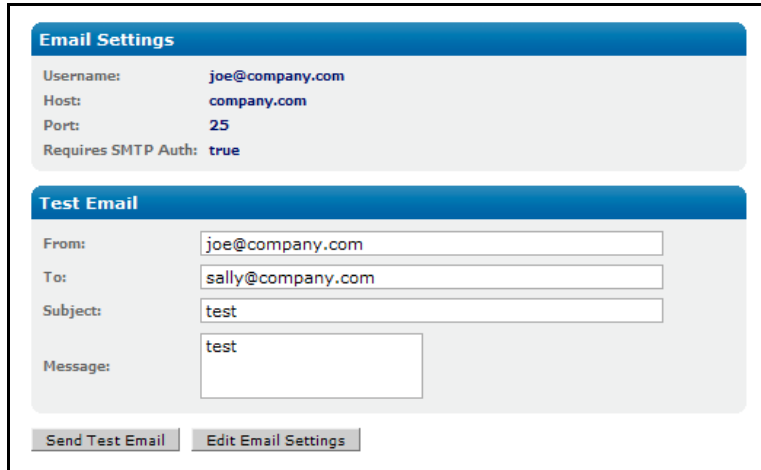

|                             |                                                                                        |
|-----------------------------|----------------------------------------------------------------------------------------|
| Test Email                  |                                                                                        |
| From                        | Enter the sender address.                                                              |
| To                          | Enter in another address to send a test email.                                         |
| Subject                     | Name a subject.                                                                        |
| Message                     | Enter test text.                                                                       |
| <b>Send Test Email</b>      | Click to send the test email.                                                          |
| <b>Edit Email Settings</b>  | Click to edit the email settings.                                                      |
| Change Distinguished Node   | Change the distinguished node. See section <a href="#">1.1.1.1, Singleton Quorum</a> . |
| Current Distinguished Node  | This names the current distinguished node.                                             |
| New Distinguished Node      | Select another site from the replication group.                                        |
| <b>Assign Selected Node</b> | Click this after selecting another distinguished node.                                 |
| Shut Down Node              | This command shuts down WANdisco at this site.                                         |

There are certain commands available while you are establishing the membership to the replication group. Once you have activated the membership, most of the commands are no longer offered. For information on creating a membership, see [3.2, Specifying Subsequent Sites](#).

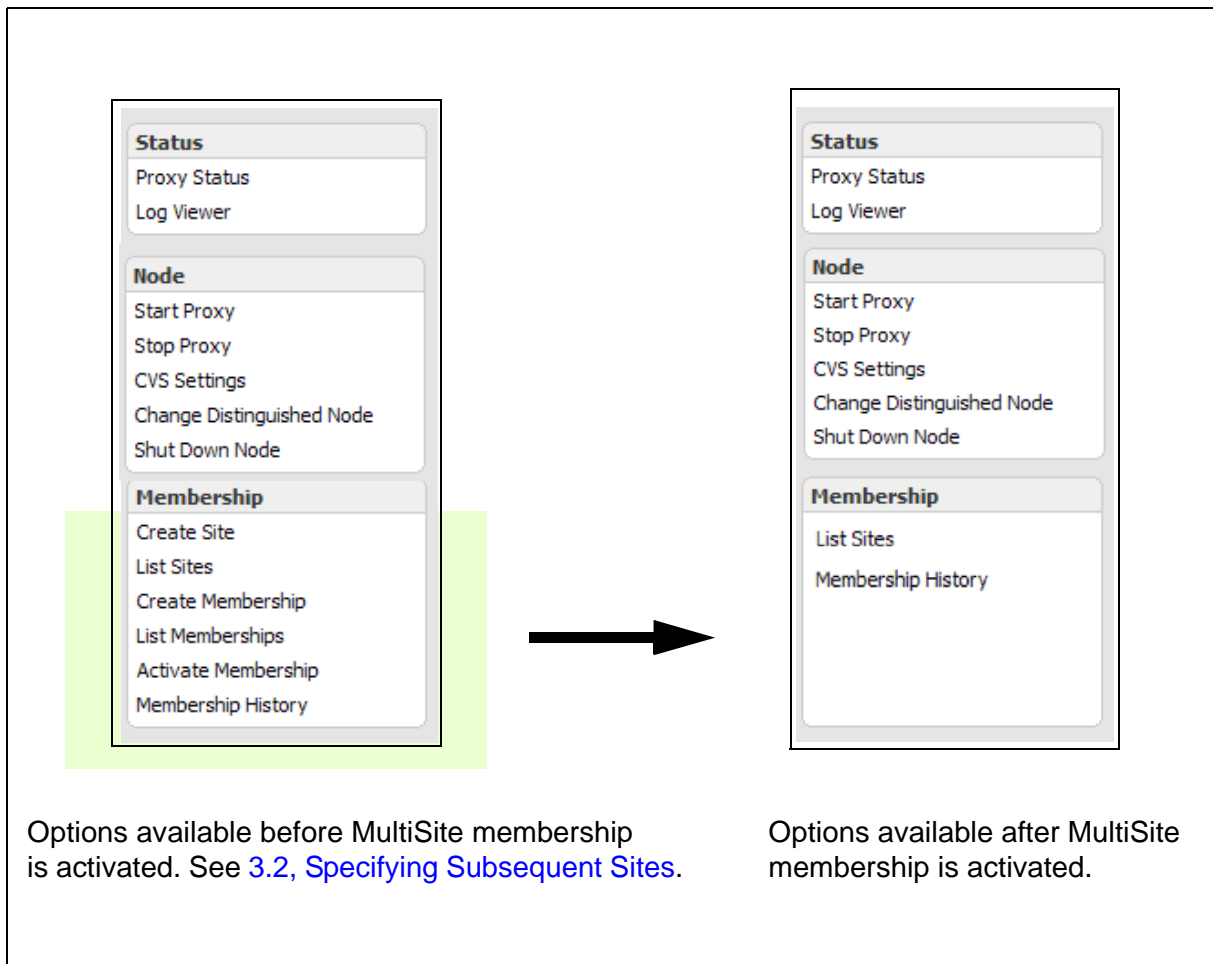

List Sites  
Membership History

shows all the sites in the replication group.  
gives a table of past membership activity

## 4.5 The Reports Page

This page is inactive for CVS MultiSite.

## 4.6 The Dashboard

There are two ways to get to the Dashboard from the Proxy page.

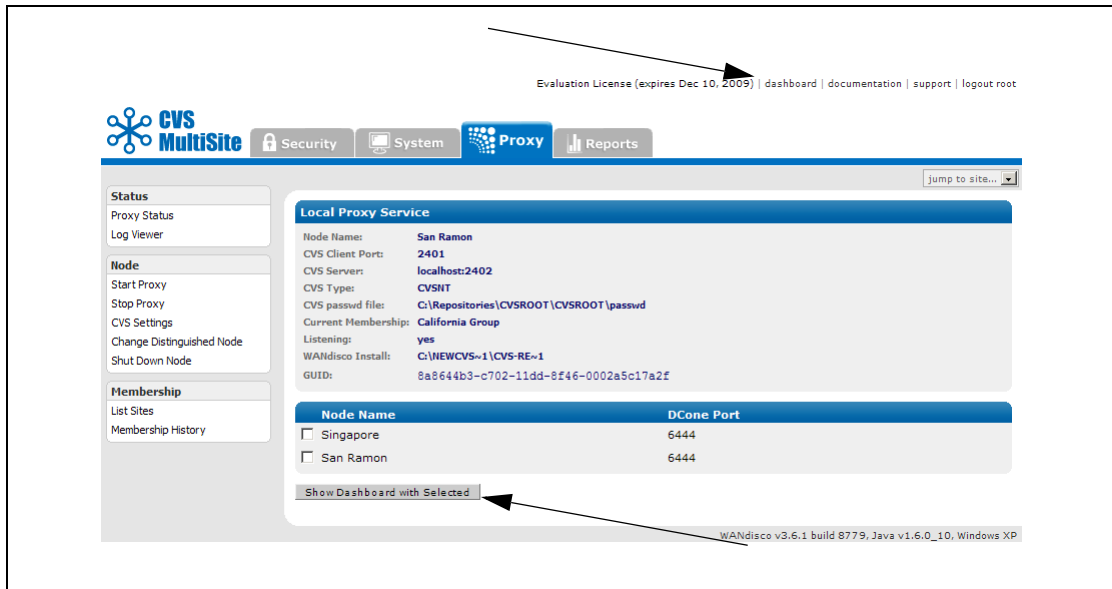

Evaluation License (expires Dec 10, 2009) | dashboard | documentation | support | logout root

CVS MultiSite Security System Proxy Reports

jump to site...

**Status**  
Proxy Status  
Log Viewer

**Node**  
Start Proxy  
Stop Proxy  
CVS Settings  
Change Distinguished Node  
Shut Down Node

**Membership**  
List Sites  
Membership History

**Local Proxy Service**

Node Name: San Ramon  
CVS Client Port: 2401  
CVS Servers: localhost:2402  
CVS Type: CVSNT  
CVS passwd file: C:\Repositories\CVSROOT\CVSROOT\passwd  
Current Memberships: California Group  
Listening: yes  
WANdisco Install: C:\NEWCVS-1\CVS-RE-1  
GUID: 8a8644b3-c702-11dd-8f46-0002a5c17a2f

| Node Name                          | DCone Port |
|------------------------------------|------------|
| <input type="checkbox"/> Singapore | 6444       |
| <input type="checkbox"/> San Ramon | 6444       |

Show Dashboard with Selected

WANdisco v3.6.1 build 8779, Java v1.6.0\_10, Windows XP

And there are two ways to get to the Dashboard from the System page.

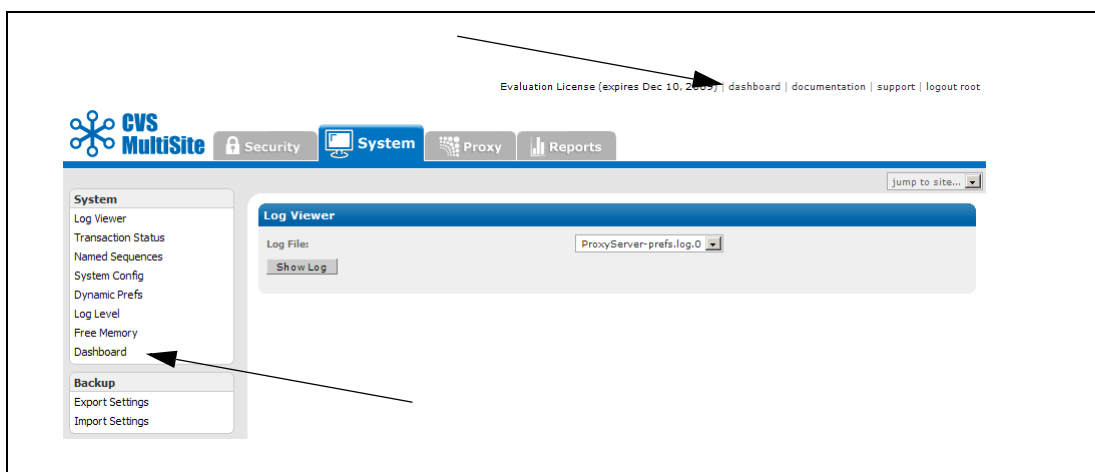

Evaluation License (expires Dec 10, 2009) | dashboard | documentation | support | logout root

CVS MultiSite Security System Proxy Reports

jump to site...

**System**  
Log Viewer  
Transaction Status  
Named Sequences  
System Config  
Dynamic Prefs  
Log Level  
Free Memory  
Dashboard  
Backup  
Export Settings  
Import Settings

**Log Viewer**

Log File: ProxyServer-prefs.log.0

Show Log

The Dashboard shows each site's transactions. As soon as MultiSite receives a CVS transaction request, that transaction joins the replication group's queue. There is one queue for the replication group. Pending transactions are not displayed, but are counted in the **Total Transactions Pending** box in the upper right.

When MultiSite finishes processing a transaction, the transaction displays in the **TX Id** field. The **Replicator** field displays the site where the transaction originated. For example, 0.0.0.0:6444 means the local site originated the transaction, while another IP address identifies that site as the transaction's originator.

[Return to Admin Console](#)
Auto Refresh Every:  [Update](#)

**Singapore v3.6.1** Up since: Fri, Dec 12, 2008 - 12:22 PM PST  
 26 Transactions Completed

|                                      |                                      |
|--------------------------------------|--------------------------------------|
| per page: <a href="#">[10]</a> 25 50 | In Progress: <b>0</b>                |
|                                      | Not Yet Scheduled: <b>0</b>          |
|                                      | Scheduled: <b>0</b>                  |
|                                      | Total Transactions Pending: <b>0</b> |

| IP            | Command | TX Id                                                               | Size | Date                         | Replicator         |
|---------------|---------|---------------------------------------------------------------------|------|------------------------------|--------------------|
| 192.168.1.106 | ci      | <a href="#">cvs-proposal-8aef3f59-c88a-11dd-92b8-001aad36533c_3</a> | 977B | Fri Dec 12 12:23:33 PST 2008 | 0.0.0.0:6444       |
|               |         | <a href="#">cvs-proposal-45c8c3d6-c88a-11dd-830f-001aad36533c_2</a> | 939B | Fri Dec 12 12:22:48 PST 2008 | 192.168.1.184:6444 |

---

**San Ramon v3.6.1** Up since: Fri, Dec 12, 2008 - 12:20 PM PST  
 26 Transactions Completed

|                                      |                                      |
|--------------------------------------|--------------------------------------|
| per page: <a href="#">[10]</a> 25 50 | In Progress: <b>0</b>                |
|                                      | Not Yet Scheduled: <b>0</b>          |
|                                      | Scheduled: <b>0</b>                  |
|                                      | Total Transactions Pending: <b>0</b> |

| IP            | Command | TX Id                                                               | Size | Date                         | Replicator         |
|---------------|---------|---------------------------------------------------------------------|------|------------------------------|--------------------|
| 192.168.1.184 | ci      | <a href="#">cvs-proposal-8aef3f59-c88a-11dd-92b8-001aad36533c_3</a> | 977B | Fri Dec 12 12:23:38 PST 2008 | 192.168.1.106:6444 |
|               |         | <a href="#">cvs-proposal-45c8c3d6-c88a-11dd-830f-001aad36533c_2</a> | 939B | Fri Dec 12 12:22:52 PST 2008 | 0.0.0.0:6444       |

## 4.6.1 Pending Transactions

There are three statuses for transactions before they are committed to CVS.

- **Not Yet Scheduled** - these transactions are in the queue
- **Scheduled** - these transactions are approved by the quorum and are waiting to be executed
- **In Progress** - these transactions are in the process of being completed

The **Total Transactions Pending** lists the total number of transactions in all statuses.

## 4.6.2 Completed Transactions

Once a transaction is completed, the Dashboard lists it in the transaction list, and that transaction is no longer considered in the **In Progress** count. The completed transaction joins the count in the **Transaction Completed** display. This display keeps count of transactions since replication began.

## 4.6.3 Refreshing the Dashboard Display

The Dashboard by default does not refresh. As MultiSite is completing many transactions, a display that refreshes often would be very confusing to read. While the order of completed transactions is the same at all sites, the real time of when a transaction is posted may vary from site to site. To refresh the Dashboard, click **Update**. You can also set the Dashboard to refresh automatically by entering a number in seconds in the field.

## 4.6.4 Transaction Status

To see details on a transaction's status, click on the transaction in the **Tx Id** column.

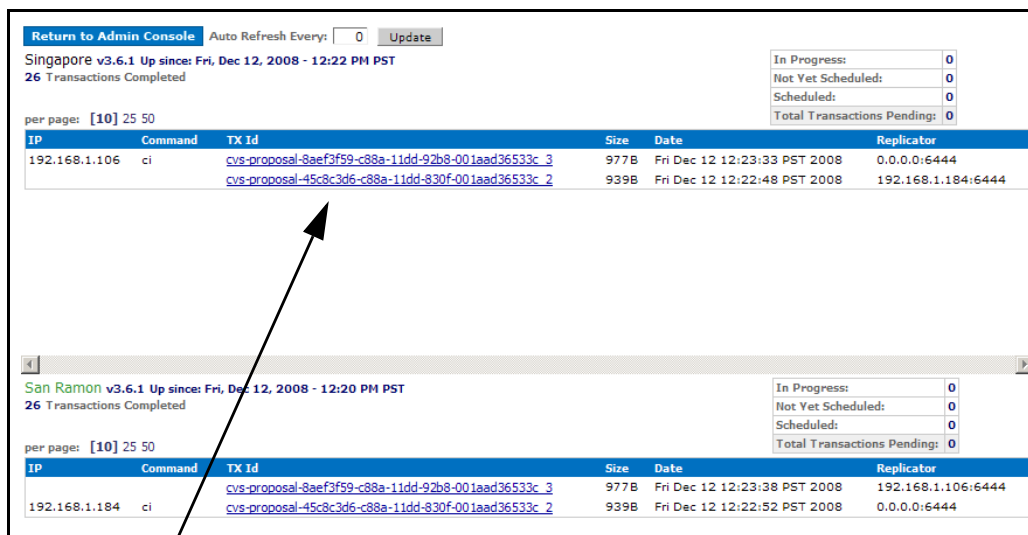

The screenshot shows the Admin Console interface with two site sections. The top section is for 'Singapore v3.6.1' and the bottom for 'San Ramon v3.6.1'. Both show '26 Transactions Completed'. Each section has a table with columns: IP, Command, TX Id, Size, Date, and Replicator. In the San Ramon table, an arrow points from the 'TX Id' column to the Transaction Status page.

| IP            | Command | TX Id                                                               | Size | Date                         | Replicator         |
|---------------|---------|---------------------------------------------------------------------|------|------------------------------|--------------------|
| 192.168.1.106 | ci      | <a href="#">cvs-proposal-8aef3f59-c88a-11dd-92b8-001aad36533c_3</a> | 977B | Fri Dec 12 12:23:33 PST 2008 | 0.0.0.0:6444       |
|               |         | <a href="#">cvs-proposal-45c8c3d6-c88a-11dd-830f-001aad36533c_2</a> | 939B | Fri Dec 12 12:22:48 PST 2008 | 192.168.1.184:6444 |

| IP            | Command | TX Id                                                               | Size | Date                         | Replicator         |
|---------------|---------|---------------------------------------------------------------------|------|------------------------------|--------------------|
| 192.168.1.184 | ci      | <a href="#">cvs-proposal-8aef3f59-c88a-11dd-92b8-001aad36533c_3</a> | 977B | Fri Dec 12 12:23:38 PST 2008 | 192.168.1.106:6444 |
|               |         | <a href="#">cvs-proposal-45c8c3d6-c88a-11dd-830f-001aad36533c_2</a> | 939B | Fri Dec 12 12:22:52 PST 2008 | 0.0.0.0:6444       |

That transaction appears in the Transaction Status page (on the System tab). You can see additional information about that transaction.



Security
System
Proxy
Reports

Evaluation License (expires Jan 26, 2010) | [dashboard](#) | [documentation](#) | [support](#) | [login](#)

**System**

- Log Viewer
- Transaction Status
- Named Sequences
- System Config
- Dynamic Prefs
- Log Level
- Free Memory
- Dashboard

**Backup**

- Export Settings
- Import Settings

**Transaction Status**

Fields marked with a \* are required.

Transaction Number\*:

Site Submitted From\*:

| Site               | SCM Status | Completion Status | Completion Time |
|--------------------|------------|-------------------|-----------------|
| 0.0.0.0:6445       | -          | Executed          | -               |
| 192.168.1.184:6444 | -          | Executed          | -               |

## 5 Managing Users

---

This chapter provides information on setting up users for MultiSite. You can create users, delete users, and search users by several criteria. You should be familiar with the Admin Console, described in Chapter 4, [Using the Admin Console](#).

If you have an existing LDAP or NIS database, you can integrate it with WANdisco. WANdisco offers a free, unsupported plugin. See the *LDAP Plugin* document at [http://www.wandisco.com/php/products\\_documentation.php](http://www.wandisco.com/php/products_documentation.php). The document contains a download link for the plugin.

### 5.1 Is WANdisco Controlling the Password File?

Upon WANdisco installation, if you selected to have WANdisco control the CVS password file, any user you enter in WANdisco can use CVS.

If WANdisco is not managing the CVS password file, and a user is entered in WANdisco but has not been registered in CVS, and he or she tries to access CVS, they would see an `Access Denied` error message in their client.

You can check if WANdisco is managing the password file by looking at the **CVS Password file** value on the Proxy tab. If a path is listed, WANdisco is managing the password file. Otherwise, you see a `not managed by WANdisco` message.

If you selected the wrong choice during installation, you can still have WANdisco manage the password file. On the Proxy tab, click **CVS Settings**. In the field **CVS Password file**, browse to the password file location. Click **Save**.

Replication passes the change along to the replication group. See the procedure [6.7, Verifying That WANdisco is Working](#).

## 5.2 Creating or Deleting Users

To add a new user, click on **Create User** in the Security tab. Specify a (CVS) username.

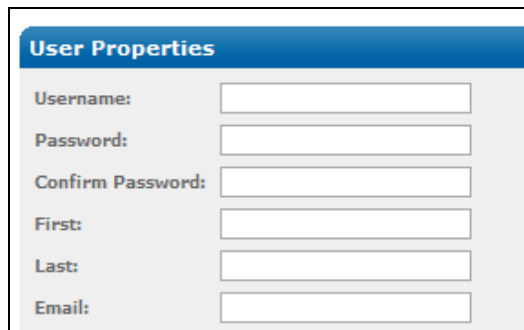

The image shows a web form titled "User Properties" with a blue header. Below the header are six input fields, each with a label to its left: "Username:", "Password:", "Confirm Password:", "First:", "Last:", and "Email:". Each label is followed by a white rectangular input box.

Enter the password, and the user's names. The email address is optional.

To remove users, click **List Users**. Select the users you want to delete with the checkbox on the left and click **Delete Selected**.

## 5.3 Listing and Searching for Users

To get a list of all the registered users, click on the **List Users** command. The User List page shows all users by default. The page size is set to show 25 users per page, but you can change that by selecting **View Per Page** on top of the user list. Arrows at the right corner allow you to scroll to the next or previous page.

Use the **Search** box to find users. Begin typing a user's first or last name, and an incremental search starts. Return to the full list by clearing the **Search** box.

All the columns in the user list are enabled for sorting. Clicking on the column header lets you sort in ascending or descending order. The sortable columns include: Userid, last name, first name, and email.

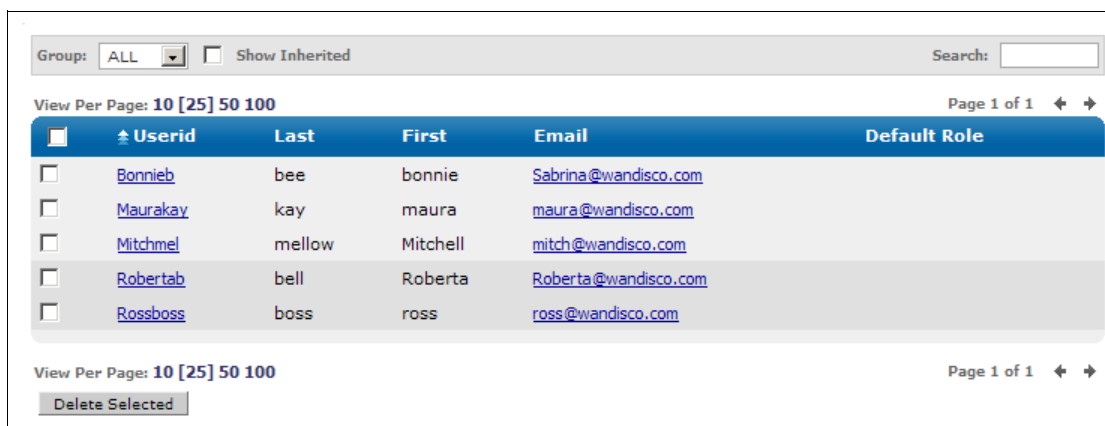

| <input type="checkbox"/> | Userid                   | Last   | First    | Email                                                          | Default Role |
|--------------------------|--------------------------|--------|----------|----------------------------------------------------------------|--------------|
| <input type="checkbox"/> | <a href="#">Bonnieb</a>  | bee    | bonnie   | <a href="mailto:Sabrina@wandisco.com">Sabrina@wandisco.com</a> |              |
| <input type="checkbox"/> | <a href="#">Maurakay</a> | kay    | maura    | <a href="mailto:maura@wandisco.com">maura@wandisco.com</a>     |              |
| <input type="checkbox"/> | <a href="#">Mitchmel</a> | mellow | Mitchell | <a href="mailto:mitch@wandisco.com">mitch@wandisco.com</a>     |              |
| <input type="checkbox"/> | <a href="#">Robertab</a> | bell   | Roberta  | <a href="mailto:Roberta@wandisco.com">Roberta@wandisco.com</a> |              |
| <input type="checkbox"/> | <a href="#">Rossboss</a> | boss   | ross     | <a href="mailto:ross@wandisco.com">ross@wandisco.com</a>       |              |

You can click on the user id hyperlink to edit the user. You can also delete as many users as you like. Delete all users by checking the checkbox in the table header, and then click the **Delete Selected** button.

## 5.4 Importing Users

You can import an existing list of users with the **Import Users** command. The import file must be a comma delimited text file, of the format `userid,lastname,firstname,email`.

If WANdisco is controlling the CVS password file, user passwords are changed to user email addresses upon importation. WANdisco recommends notifying users to change their CVS password, as described in the next section.

### 5.4.1 Having CVS Users Change Their Passwords

Use this only for users imported with the **Import Users** command. Importation changes users' passwords to email addresses. Users can change CVS passwords in WANdisco without logging in to WANdisco. Have the users go to

`http://localhost:6444/`

The Admin Console appears. Have the users click on **Change User Password**.

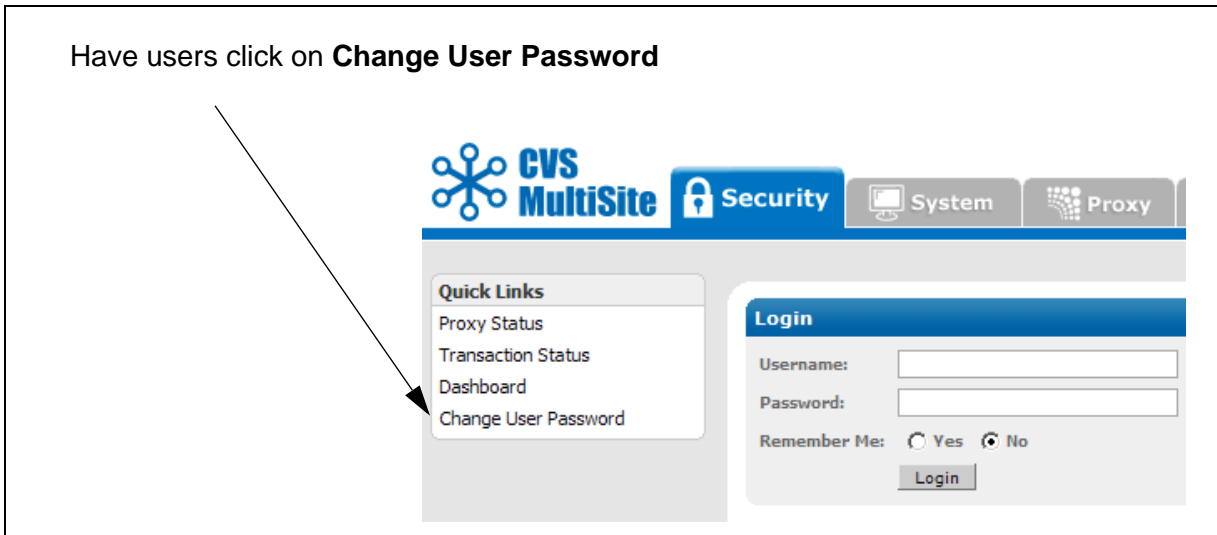

The Change Password box appears. Users can enter their CVS username, and their password (which is now their email address). Have them enter a new password and confirm it, then click **Change Password**. The users have successfully changed their passwords.

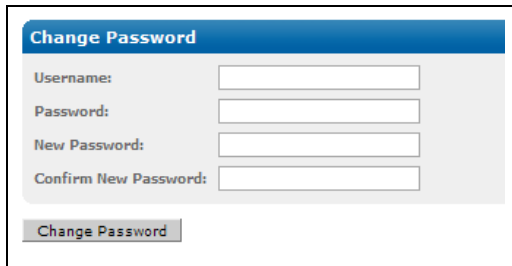

## 6 Procedures

---

### 6.1 Temporarily Disabling CVS Access at Selected Sites

**NOTE:**

---

This procedure involves taking CVS offline. Please follow your company procedures about notifying CVS users of down time.

---

#### 6.1.1 Temporarily Disabling CVS Access at Selected Sites

You can stop transactions at one or more sites. For a discussion of stopping one, but not all, sites, see [1.1.3, WANdisco is Listening](#).

**NOTE:**

---

Do not use this procedure if you want to do a synchronized stop. For a synchronized stop, see [6.3, Performing a Synchronized Stop](#).

---

- Step 1 After notifying your users of maintenance, navigate to the Proxy page.
- Step 2 Stop WANdisco at this site. Click **Stop this proxy only**.
- Step 3 Repeat steps 2 and 3 for each site you want to stop.
- Step 4 To start a site, click **Start Proxy**. The replication group catches up the re-started site on any transactions that occurred at the sites that remained up.
- Step 5 Remember to re-start each site that you stopped.

#### 6.1.2 Temporarily Disabling CVS Access at All Sites

To stop all sites at once, do a synchronized stop. See [6.3, Performing a Synchronized Stop](#).

## 6.2 Establishing a Baseline for Replication

Before starting WANdisco, you should ensure that all sites start with an identical copy of the repository (the cvsroots) - identical in all respects, except as noted below.

Depending on the size of your repository and available bandwidth to the remote sites, you can decide whether to copy or sync the repository over the network or ship a copy of the repository on a physical medium (for example, a CD, DVD or hard disk). Select the method that works best for your situation.

If you already have an older copy of the repository at the remote sites, for example, if, prior to deploying WANdisco, you were using a master-slave replication solution such as cvsup, choose the **Synchronize** procedure.

### 6.2.1 Copying the Subversion Database

Otherwise, start by estimating how long it may take you to copy the repository over the network by determining the size of your repository and the bandwidth available to the remote sites. If you conclude that it takes too long, you will want to ship the repository to the remote sites on a physical medium.

- Step 1 Determine the size of the repository. From a Unix command prompt, `cd` to your repository and type

```
du -s
```

This reports the size of your repository in kilobytes.

- Step 2 Determine the network bandwidth. Copy a reasonable-sized file (say 100 megabytes) to the remote site using any means available (example, `scp` or `ftp`). Time the copy.

- Step 3 Estimate how long the copy will take. Using the information gathered above, you can estimate how long it can take you to copy the repository to the remote sites over the network. For example, if copying a 100 megabyte file over the network took 10 minutes, copying your 5 gigabyte repository may take about 500 minutes (8 hours and 20 minutes).

### 6.2.2 Synchronizing With an Older Remote Copy

You can use `rsync` to sync up an older remote copy with your master copy. For example, from the machine with the master copy of myRepository, type

```
rsync -rvlHt /path/to/myRepository remoteHost:/path/to
```

Note that the final element, `myRepository`, is not specified in the `remotehost`'s path. For further information, consult the `rsync` man pages.

## 6.2.3 Copying Over the Network

Use this procedure if:

- You do not have an older remote copy; i.e., you are copying the entire repository over.
- Your repository is small enough.
- You have enough network bandwidth to copy the repository to the remote sites in reasonable time.

Step 1 Ensure that the repository is not in use. If necessary, shut down the SCM server. For example, type

```
/etc/init.d/xinetd stop
```

Step 2 Package the master copy of your repository.

Step 3 Copy the package to the remote host.

Step 4 Log in to your remote host and unpackage the repository. For example, on the server with the master copy, type

```
cd /path/to
tar pzcf myRepository.tgz myRepository
ssh remoteHost mkdir -p /path/to
scp myRepository.tgz remoteHost:/path/to/
log into remoteHost
cd /path/to
tar pzxf myRepository.tgz
```

## 6.2.4 Shipping on a Physical Medium

If copying over the network may take too long, you can ship the repository to the remote destination on a physical medium, such as a CD, DVD or hard disk. Note that you do not have to wait for the baseline to be available at all sites before using WANdisco. Instead, you can follow the procedure below.

Using WANdisco before the baseline is available at all sites

- Step 1 Deploy WANdisco as usual, but do not start the WANdisco server at the sites where the baseline is not yet available.
- Step 2 When choosing a quorum, ensure that the sites where WANdisco can be started are sufficient to form a quorum. The simplest way to do this is to

choose the Singleton Quorum, and choose the site that has the master copy of the repository as the distinguished node.

### Safe Differences

The only things that can safely differ in the baselines across your sites are post-commit triggers. For example, if you generate email notifications from a post-commit trigger, it is a good idea to do that at only one site to avoid generating duplicate email notifications.

### Common Pitfalls

It is important that the repositories are identical in all respects except as noted above. A common mistake when the desired baseline is an empty repository is to `init` a new empty repository at each site. Instead, you should `init` the repository at one site, and copy the empty repository to other sites.

For CVS, there may be no negative consequences to this mistake, but an empty repository is so small, you might as well play it safe.

## 6.3 Performing a Synchronized Stop

### NOTES:

---

A synchronized stop completes only when all sites are available. If one or more sites are unavailable, the process suspends until they are available.

This procedure involves turning CVS into read-only mode. Please follow your company guidelines on notifying CVS users of maintenance.

---

- Step 1 Click on **Stop Proxy**. Go to the Proxy tab on the Admin Console. **Stop Proxy** is listed on the left.
- Step 2 Check the **Synchronized stop of all proxies** radio button. All sites stop. Pending transactions get completed, but WANdisco accepts no further client transactions. The CVS servers go into read-only mode.
- Step 3 To restart WANdisco at all the servers, refresh the Proxy page. Click **Resume**.

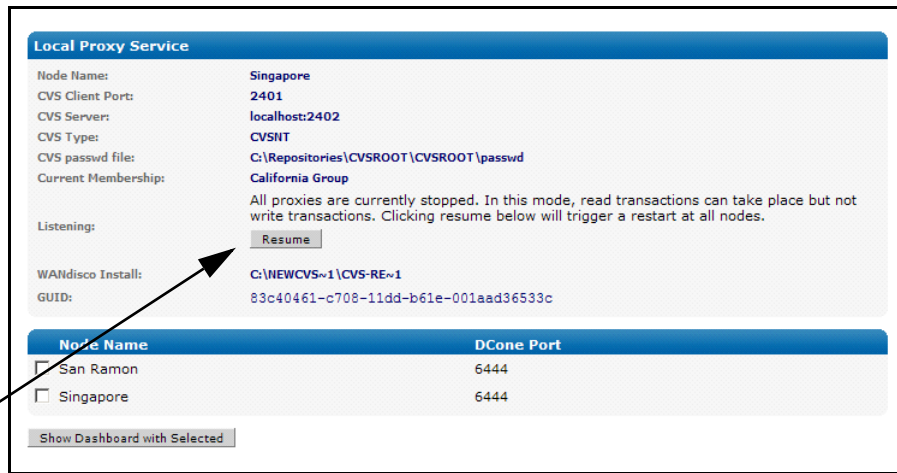

**Local Proxy Service**

Node Name: Singapore  
CVS Client Port: 2401  
CVS Server: localhost:2402  
CVS Type: CVSNT  
CVS passwd file: C:\Repositories\CVSROOT\CVSROOT\passwd  
Current Membership: California Group

Listening:  no

WANdisco Install: C:\NEWCVS~1\CVS-RE~1  
GUID: 83c40461-c708-11dd-b61e-001aad36533c

| Node Name                          | DCone Port |
|------------------------------------|------------|
| <input type="checkbox"/> San Ramon | 6444       |
| <input type="checkbox"/> Singapore | 6444       |

The page refreshes, and you can see the Listening field display is now **yes**.

## 6.4 Adding a Site to the Replication Group

You can add a site to an existing replication group. Notify WANdisco of the IP addresses of the new sites, and WANdisco sends you a new installation file and license key file.

Follow the instructions in [3.4, Installing Upgrades](#), adding the new sites to the replication group.

Note that you run the installer at the initial install site, which auto-populates previously filled out fields. You probably want to have WANdisco not package the repository, and just copy it for the new sites.

As you bring each previously existing site out of quarantine, you can release it to users. There should be minimal downtime; the longest task is copying the repository to the new sites.

## 6.5 Removing a Site from the Replication Group

You can remove a site or sites from an existing replication group. Follow the instructions in [3.4, Installing Upgrades](#), but just eliminate the site from the group.

Note that you run the installer at the initial install site, which auto-populates previously filled out fields. You should choose to have WANdisco not package the repository, since the repositories are already in sync.

## 6.6 Changing a prefs.xml File

The prefs.xml files for sites are located in `cvs-replicator/config`. Each file contains all preference information for the sites in the group.

If you make changes that affect more than one site, you must change each site's specific file. But if your change affects just one site, you can change just that site's prefs.xml file.

### 6.6.1 Changing One Site's prefs.xml File

- Step 1 Shut down the site or sites where you changed the prefs.xml file. Go to the Proxy page and click **Shut Down Node**.
- Step 2 Make the desired changes to one or more prefs.xml file.
- Step 3 Restart the site or sites you stopped. At the command line for each stopped site, at `cvsreplicator/bin`, type

```
cvsreplicator
```

The changes you made in the prefs.xml file or files are now in effect.

## 6.6.2 Changing All Sites' prefs.xml File

- Step 1 Perform a synchronized stop. See [6.3, Performing a Synchronized Stop](#).
- Step 2 Make the desired changes to each site's prefs.xml file.
- Step 3 Restart WANdisco at all servers. Follow the last step in [6.3, Performing a Synchronized Stop](#): click **Resume**.

## 6.7 Verifying That WANdisco is Working

To check if WANdisco is replicating, verify there are commit transactions posted to the log file `cvs-replicator/logs/ProxyServer-prefs.log`.

```
INFO: [listen-1] Listening on port : 0.0.0.0/0.0.0.0:6445
1219077847375 org.nirala.communication.transport.DConeNet.AsyncConnector
makeConnection
INFO: [main] Connection request to Node Id = c66b6db9-6a50-11dd-8675-
001aa036534c, host = 192.168.1.15, port = 6666, timed out in 500ms
1219077847875 org.nirala.communication.transport.DConeNet.AsyncConnector
makeConnection
INFO: [main] Connection request to DFTPEndpoint - Node Id =
192.168.1.156666, host = 192.168.1.15, port = 6666, timed out in 500ms
1219077848578 org.nirala.admin.DiskMon start
INFO: [main] Diskmon is monitoring C:\Thursday\cvs-ha\systemdb every
15min
1219077849000 org.nirala.communication.transport.DConeNet.ListenReactor
setupListener
INFO: [listen-1] Listening on port : 0.0.0.0/0.0.0.0:2403
1219077849000 org.nirala.communication.transport.cvsproxy.ProxyServer
onStartedProxyListen
INFO: [main] CVS Proxy listener is now turned ON at port :2403
1219077853765 org.nirala.communication.transport.DConeNet.Listen-
Stage$TCPStopListening onStop
INFO: [listen-1] Host: 0.0.0.0, Port: 2403 Stopped Listening.
1219077853765 org.nirala.communication.transport.cvsproxy.ProxyServer
onStopProxyListener
INFO: [p-queue-1] CVS Proxy listener is now turned OFF at port :2403
1219077872328 org.nirala.communication.transport.DConeNet.ListenReactor
setupListener
INFO: [listen-1] Listening on port : 0.0.0.0/0.0.0.0:2403
1219077872328 org.nirala.communication.transport.cvsproxy.ProxyServer
onStartedProxyListen
INFO: [mqueue-1] CVS Proxy listener is now turned ON at port :2403
```

## 6.8 Installing a .jar File Patch

Follow these steps to install a `cvs-replicator.jar` patch to an existing MultiSite installation.

**NOTE:**

---

Always read the `readme` file and `Release Notes` first.

---

- Step 1 Download the `cvs-replicator.jar` file.
- Step 2 Verify the md5 checksum.
- Step 3 Move the existing jar file to a back up directory. (All jar files in the `/lib` directories are in the `WANdisco CLASS` path.)
- Step 4 Stop MultiSite. See [6.3, Performing a Synchronized Stop](#).
- Step 5 Copy the new jar file to the `lib` directory.
- Step 6 Restart the group. Click **Resume** on the Proxy page.
- Step 7 Confirm the upgrade by checking the dashboard for the newer version, and check the log file under `cvs-replicator/logs` for the start header with the new version.

## 6.9 Changing WANdisco's Root Login

By default, the login for the Admin Console is `root`, and the password is user-defined during installation. That way, all sites initially have the same login and password.

You can change the login for any site. Each site can have its own login, however if you do change it, ensure that all site administrators throughout the replication group know it. If four sites each had their own logins, then each administrator could see the other sites in the Dashboard, and could not access the other sites' Admin Consoles without entering the passwords for those sites.

**NOTE:**

---

You can have different passwords for different sites, however WANdisco recommends you keep administration simple, and have the same login and password for all sites.

---

To change the login at a particular site, enter the following in that site's `prefs.xml`.

```
<Security>
  <Admin>
    <user>newlogin</user>
  </Admin>
```

</Security>

See the procedure [6.6, Changing a prefs.xml File](#).

## 6.9.1 Changing the Password

You can change the WANdisco password at any time by using the Change Admin Password command on the Users tab.

**NOTE:**

---

This changes the password for this site only. The password change does not get replicated.

---

Ensure that all site administrators throughout the replication group know the new password.

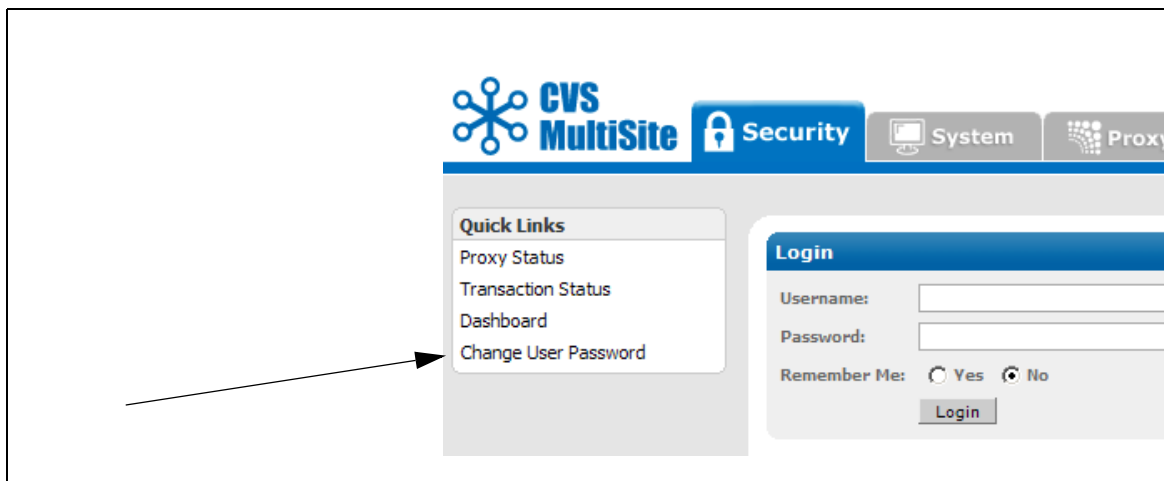

## 6.10 Adding Another Repository To An Existing Group

You can add additional repositories to existing replication groups. Assuming you have the new repository at one site, you have two options on how to proceed.

- You can copy the repository, and then continue to use it at the one site while it is being transferred to the other locations. As each repository arrives at a site, you then must perform an rsync with the first site to obtain the changes that occurred while the repository was in transit. You must rsync at each of the other locations.
- Alternatively, you can copy the repository, and then take it offline until the copy arrives at each of the other sites.

In either case, here are the general steps.

- Step 1 Copy the new repository to all existing sites.
- Step 2 Edit the `--allow-root` line in the `xinetd.d` or `inetd.conf` script to include the new server. Each replicated repository has to be in the same location at each site.
- Step 3 Ensure that the new repositories are in synch at each site.
- Step 4 You can begin using the additional repository.

## 6.11 Restricting PSERVER Access to CVS MultiSite Host

You can restrict clients' direct access to the CVS server. Use one of these methods.

- Method 1      The `only_from` attribute of `xinetd.conf(5)` is used to restrict a remote access to a particular service. The value for the 'only\_from' attribute should be '127.0.0.1' if WANdisco is running on the same server as the CVS pserver process. The value needs to either be a valid IP address for the server running the CVS MultiSite host, or the IP address that CVS MultiSite is using to communicate to the CVS pserver when CVS MultiSite is running on a separate host from the CVS pserver.

Following is an example of a `/etc/xinetd.d/cvspserver` that restricts the access to localhost. It assumes that the `cvcreplicator` is running on localhost, and `cvs` server is listening on port 2402.

```
service cvspserver
{
  disable = no
  socket_type = stream
  wait = no
  user = root
  log_type = FILE /var/log/cvspserver
  protocol = tcp
  only_from = cvsreplicator
  port = 2402
  server = /usr/bin/cvs
  server_args = --allow-root=/data/cvs pserver
}
```

- Method 2      Disable ssh forwarding. This is done by modifying `/etc/ssh/ssh_config` and setting `ForwardAgent` to `no`. From the manual page of `ssh`: `ForwardAgent` specifies whether the connection to the authentication agent (if any) is forwarded to the remote machine. The argument must be `yes` or `no`. The default is `no`.

Agent forwarding should be enabled with caution. Users with the ability to bypass file permissions on the remote host (for the agent's

- Method 3      `-domain socket`) can access the local agent through the forwarded connection. An attacker cannot obtain key material from the agent. However, they can perform operations on the keys that enable them to authenticate using the identities loaded into the agent.

- Method 4      By setting the CVS repository permission to a local user and local group, access to the CVS repository can also be restricted. For example, create a local user **cvuser** and a local group **cvsgroup**. By changing the permission on the CVS repository to this local user and group, no other user can directly write to the repository. The following configuration in `CVSROOT/config`, `CVSROOT/checkoutlist` and by adding entries in `CVSROOT/passwd` allows the users to commit to the repository.

Modify `CVSROOT/config` and set `SystemAuth` to `no`.

Add `passwd` line in the `CVSROOT/checkoutlist` file. For more details, read [http://ximbiot.com/cvs/manual/cvs-1.11.21/cvs\\_18.html](http://ximbiot.com/cvs/manual/cvs-1.11.21/cvs_18.html) section 181.

For each user accessing the repository, add a line in the `CVSROOT/passwd` file. For more details, read Setting up the server for password authentication at [http://ximbiot.com/cvs/manual/cvs-1.11.21/cvs\\_2.html](http://ximbiot.com/cvs/manual/cvs-1.11.21/cvs_2.html) section 30.

```
wandisco:$1$mS0G8tBk$T6K1/sHmMEPiM6sgi6rH6.:cvsuser
```

Please also read the following article: *Managing CVS Security* <http://www.linux.ie/articles/tutorials/managingaccesswithcvs.php?style=printer>.

## 6.12 Using CVS admin -l to Lock Parts of CVS Repository

You can use the `cvs admin -l` command in conjunction with a script that puts metadata in the CVS RCS files to indicate whether a file revision or branch has been locked. One such script that is bundled with CVS sources is `cvs/contrib/rcslock`. The specific steps are:

- Step 1 Add `rcslock` to the `CVSROOT/checkoutlist` file, and commit the file. The file gets replicated.
- Step 2 Add the `rcslock` script to `CVSROOT` and commit it. This allows the `rcslock` file to be replicated to all CVS repositories.
- Step 3 Add the `rcslock` script to the `commitinfo` trigger: for example, `ALL $CVSROOT/CVSROOT/rcslock`. This causes the `commitinfo` trigger to be checked in and replicated.
- Step 4 Now, you can issue the `cvs admin -l` or `-u` command to lock and unlock. The `admin` command is replicated and causes all the repositories to be locked in unison.

Note that `rcslock` is an open source script, and not maintained or supported by WANdisco. The `cvs admin` command works in conjunction with a `rcslock`-like script. This has nothing to do with the WANdisco CVS replicator, per se. We just replicate the command and CVS does the rest.

## 6.13 Managing CVS Security

We would like to refer you to the following article in addition to the CVS manual. *Managing Access with CVS* <http://www.linux.ie/articles/tutorials/managingaccesswithcvs.php?style=printer>.

## 6.14 Using CVS Triggers for Sending E-mails

Many administrators like to set up CVS backend triggers that fire whenever a CVS user commits a set of file changes. With a single/master CVS server setup, e-mails can be initiated once when the `loginfo` trigger fires.

However, with the addition of WANdisco, unless some safeguards are put in place, all your CVS replicas may fire the `loginfo` trigger. This could potentially cause multiple e-mail notifications. Most likely, developers do not want several e-mails for the same transaction.

The easiest way to remedy this is to designate any one node as the “e-mail hub.” Just enable the `loginfo` trigger to fire from a single site within the replication group. Alternatively, you could use the time of day to fire the e-mail alerts from a specific site. For example, you could modify the `loginfo` trigger to send e-mails from India during 9:00 a.m. to 5:00 p.m. IST, and from the US during 9:00 a.m. to 5:00 p.m. PST.

It is allowable to have asymmetry in the e-mail triggers, but make sure not to disable the `commitinfo` trigger on any node. That may cause a CVS commit transaction to abort at some sites but commit at other sites. The `commitinfo` trigger behavior at each site should be deterministic and should not cause the replicas to go out of sync.

When sending e-mail, it is important to set up the e-mail configuration to avoid long blockages or delays. Many times, an administrator uses the default SMTP settings on the CVS host. These settings by default try to use the organization domain specific e-mail server to send e-mails (by looking up the MX records corresponding to the organization's domain).

The organization-wide SMTP server may be located on a remote WAN, or it may have throttling policies for e-mails originating from the same IP address to cut down on spam. This can cause it to block or reject e-mails, which may in turn cause scripts (like the `loginfo` script) to hang or terminate. To avoid such problems with e-mail triggers, WANdisco recommends that you set up a local e-mail hub or a local SMTP agent/server. The local SMTP server should preferably be on the same host as the CVS server. It should be set up to forward/relay e-mails to the organization-wide SMTP server. This ensures the e-mail triggers are a lot faster and just need to enqueue the e-mails to the local SMTP server.

## 6.15 Replicating User/Auth Database

### NOTE:

---

This procedure is valid only if WANdisco is not managing the user password files.

---

Let's walk through a solution based `CVSROOT/passwd` file, and then we will generalize it. Please note that CVSNT does not support the `passwd` file being submitted into version control.

This discussion presumes you have a replicated CVS repository already set up using WANdisco CVS MutliSite.

By default, the `CVSROOT/passwd` file is not under revision control in the CVS repository. First, make sure you add it to `CVSROOT/checkoutlist` (see the CVS manual) and commit the checkoutlist administrative file into the repository.

This way, whenever you add or commit the `CVSROOT/passwd` file, the CVS server performs a rebuild of administrative files and checks out a copy of the `passwd` file in the `CVSROOT` directory automatically.

If these commands were committed via the replicator, you have a replicated password file. Any changes you make (user add/delete, `passwd` modify, etc.) is automatically propagated to all replicas and the user database stays synchronized.

Now let's try to generalize this to any user database file, say `/etc/passwd`.

Since you are allowed to add any administrative file into `CVSROOT`, you could follow the above process and have, say `/etc/passwd`, linked to a specific `CVSROOT/passwd`. Any changes you make and commit are replicated and `/etc/passwd` is auto updated with version control.

If you have a non file-based user repository like LDAP, you can contact WANdisco for adding bidirectional replication with the WANdisco SDK.

## 6.16 Finding the Last Committed Transaction

Even though committed transactions are always in the same order for each node, the timing of the commits usually varies from node to node. So unless there are no CVS users logged in, you probably are going to have variations per node for committed transactions.

Go to any node's Dashboard. Type

```
http://<IP address>:<WANdisco port number>/dashboard2
```

You see all the nodes on the Dashboard to compare the listed transactions.

## 6.17 Verifying System Integrity

WANdisco recommends performing periodic incremental diffs to ensure all the remote CVS repositories are in sync. This could be done periodically using a cron job, for example. But do remember that because of the way WANdisco replication works, it is possible for two CVS repositories to appear to be different while updates are happening. In other words, if you take a snapshot while updates are being applied, the snapshots could differ from each other. This does not indicate a failure of WANdisco replication.

So, when making snapshots for comparing, please make sure repositories are not being updated. The easiest way is to -

- disable client access to the replicator using Admin Console
- wait briefly for the replication group to quiesce

To do the actual diffs you are welcome to download a fast compare tool from the WANdisco support web site. Go to [http://www.wandisco.com/php/support\\_downloads.php](http://www.wandisco.com/php/support_downloads.php). This tool uses MD5 checksums to speed up comparison of CVS branches at multiple sites on a low-bandwidth, slow network link.

Alternatively you can :

- Do a local CVS checkout without the RCS keywords expansion, using the -kk option. This will help avoid spurious conflicts.
- Bring the snapshot to the machine where you would be doing the diff, perhaps using rsync.

## 7 Replicator Management

---

### 7.1 Changing the Quorum Type

Quorum is established when you define a membership. See step 38 in Chapter 3, [Installation](#). If you want to change the quorum type from what was initially defined, please call WANdisco support at 887-207-1439.

### 7.2 Rotating the Distinguished Node

For replication groups with a Singleton quorum (or Multiple quorum with a even number of sites), you can schedule the Distinguished Node to change, based on physical location around the world.

For example, say you have CVS MultiSite in San Jose, CA, in Madrid, and in New Zealand. Since being the distinguished node offers the fastest response time, you would want each of those locations to take advantage of the time they could each be the distinguished node.

To do that, you would edit the Preferences file **at only one location**. Use the local time for that location, and figure out the times the distinguished node would change.

Leave the existing `<Quorum>` tag alone, and add two new tags, `<Quorum>` and `<Schedule>` under the `<AgreementManagerList>` tag. For example,

```
<AgreementManagerList>
  <AgreementManager name="52ec6735-ce20-11d9-8e57-00065be02953">
    <DisplayName>cvs-am</DisplayName>
    <Quorum>
      <Schedule>
        <at name="09:00 AM">
          <!-- San Jose Site --> <DistinguishedNode>fb7723de-ce1e-11d9-
ae57-00065be02953</DistinguishedNode>
        </at>
        <at name="08:30 PM">
          <!-- Madrid Site --> <DistinguishedNode>659a768d-ce1f-11d9-
aeec-00065be02953</DistinguishedNode>
        </at>
        <at name="03:00 AM">
          <!-- New Zealand Site --> <DistinguishedNode>3fae40f3-ce20-
11d9-8e6a-00065be02953</DistinguishedNode>
        </at>
      </Schedule>
    </Quorum>
  </AgreementManager>
</AgreementManagerList>
```

The time syntax is `hh:mm:ss: AM|PM`. Seconds are optional.

**NOTES:**

---

If you do rotate your distinguished node, the other sites' Preferences files do not reflect the rotation. You must rely on the Admin Console (available at all sites) to display the current distinguished node (the site's name displays in green).

Make sure that the local MultiSite administrators know about the change.

---

See [6.6, Changing a prefs.xml File](#).

## 7.3 Configuring Two Replication Groups On One Server

If you have more than one cvsroots, and experience performance issues with one root while waiting for transactions to process from the other root, you may want to consider separating the roots. In this case, you would install two WANdisco's on the same server, each one pointing to a different cvsroots. That way, traffic for one path does not impact traffic for the other path.

To implement this, you need to define separate port numbers so that the WANdisco instances have unique port numbers.

<b>WANdisco - First Instance</b>	
WANdisco proxy port	2401
DConE port (replication port)	6444
pserver port	2402
<b>WANdisco - Second Instance</b>	
WANdisco proxy port	2403
DConE port (replication port)	6555
pserver port	2404

Install another instance of WANdisco in a different directory. The password files are going to be different for the two different instances, which creates a bit of an administrative burden on the WANdisco admin.

Duplicate the `cvspserver` file in `/etc/xinet.d`, and add a service named `cvspserver2` in the `/etc/services` file.

## 7.4 Selective Replication

By default, WANdisco replicates all cvsroots associated with a CVS pserver repository. However, you can specify a set of cvsroots for replication, and specify another set of cvsroots that is not replicated (for a local site only).

**NOTE:**

---

Selective replication is determined at the **cvsroot** level, not the **module** level.

---

You use Includes (for replicated cvsroots) and Excludes (for non-replicated cvsroots) in the `prefs.xml` file to identify the cvsroots. Identify the cvsroots using Perl Regular Expression syntax. WANdisco passes any write operation on excluded cvsroots through to the CVS repository directly.

Consider the following example:

```
<CVSProxy>
  ....
  <cvsroots>
    <Includes>
      /home/root1/. *
      /home/root2/. *
    </Includes>
    <Excludes>
      /home/root3/. *
    </Excludes>
  </cvsroots>
  ....
</CVSProxy>
```

The above rules replicate any CVS operations on files like

```
/home/root1/module1/file
/home/root2/module2/file
```

WANdisco does not replicate CVS operations on the files like

```
/home/root3/module3/file
```

as they fall under the Excludes pattern.

Note that cvsroots should be specified in their slash-terminated form - thus, specify `/a/b/c/` and not `/a/b/c`.

The Excludes section always takes precedence over Includes. If you only specify the Excludes section, that is equivalent to allowing all cvsroots and denying only the cvsroots that match the

patterns specified with Excludes. If you only specify the Includes section, then allowed cvsroots are constrained to only the ones that match the patterns specified in Includes.

When you have enabled selective replication, an informational message appears in the log file on initialization. The message is similar to:

```
1235087847812 org.nirala.communication.transport.cvsproxy.ProxyPrefs
initCVSRootPrefs
INFO: [main] Using selective replication
includes = /home/root1/*.
          /home/root2/*.
excludes = /home/root3/*.
```

## 7.5 Setting WANdisco to Start Up on System Boot

You can easily have WANdisco start up on system boot. To start up on boot, edit the `init.d` scripts. You must make modifications based on your operating system.

For examples for RedHat and SuSe, see [http://wandisco.com/php/support\\_downloads.php](http://wandisco.com/php/support_downloads.php).

Here is an `/etc/init.d/cvsreplicator` script for Gentoo Linux.

```
#!/sbin/runscript
#
# Gentoo Linux dist compatible rc script for
# starting/stopping cvsreplicator
#
# Copyright WANdisco
#

<start command = cvsreplicator>

REP_HOME="/home/admin0/cvs-security"
REP_OPTS="-wdog -emailadmins@company.com"
export JAVA_HOME="/export/share/apps/jdks/1.5.0"
USER="admin0"

pidfile="my.pid"

depend() {
  need net
}

checkconfig() {
  if [ ! -f $REP_HOME/bin/<start command> ]; then
    eerror "No ${REP_HOME}/bin/cvsreplicator present"
    return 1
  fi
}
```

```
prog=${<start command>}
}

start() {
checkconfig || return 1
ebegin "Starting $prog:"
ulimit -S -c 0 >/dev/null 2>&1
ulimit -n 65000 >/dev/null 2>&1
RETVAL=0
start-stop-daemon --start --quiet -u ${USER} --chuid ${USER} --exec
${REP_HOME}/bin/<start command> -- ${REP_OPTS}
RETVAL=$?

if [ "$RETVAL" -gt 0 ]; then
eend $RETVAL "Failed to bring up cvsreplicator"
return $RETVAL
fi
eend $RETVAL
}

stop() {
checkconfig || return 1
ebegin "Shutting down $prog:"
su ${USER} -c \"${REP_HOME}/bin/shutdown\" >/dev/null 2>&1
start-stop-daemon --stop --quiet -u ${USER} --pidfile ${REP_HOME}/logs/
${pidfile}
RETVAL=$?
if [ "$RETVAL" -gt 0 ]; then
eend $RETVAL "Failed to shutdown cvsreplicator"
return $RETVAL
fi
eend $RETVAL
}
```

## 7.6 Setting WANdisco Up as a Windows Service

WANdisco offers a Perl plugin so you can set up WANdisco as a Windows service. The plugin allows WANdisco to work with the Windows Service Control Manager.

You need a Windows login account with a valid password to implement this service. This plugin is not compatible with Active Perl 5.10x; you would have to downgrade to 5.8 to use the service.

Follow these steps to set up WANdisco as a Windows service. Perform the procedure at every site you want the service.

- Step 1 Find the Windows Service Installer Perl plugin script here:  
[http://wandisco.com/php/support\\_downloads.php](http://wandisco.com/php/support_downloads.php).
- Save page as `winservice.pl` and put it in the `cvs-replicator\bin` directory.
- Step 2 Install the Perl module for Windows Services. At the command line, type
- ```
ppm install http://www.roth.net/perl/packages/win32-daemon.ppd
```
- Step 3 Install the Windows service. At the command line, in the `cvs-replicator\bin` directory, type
- ```
winservice.pl -install
```
- (Type `winservice.pl` to see all parameters for the command.)
- Step 4 Optional. Change the password for this service. Go to the Services window ( > *Control Panel* > *Administrative Tools* > *Services*). Double click on CVS MultiSite. At the Log On tab, change the password and confirm it. Click **OK**.
- Step 5 To add email service for WANdisco's watchdog:
- Stop CVS MultiSite.
  - Edit the `winservice.pl` script. Remove the comment from the line, and add a valid email address.

```
$NOTIFY_EMAIL = 'maurice@wandisco.com';
```
  - Restart CVS MultiSite.

The service creates a `winservice.log`, located in the `cvs-replicator\logs` directory.

## 7.7 Deferred Writes

WANdisco by default waits 60 seconds when a write transaction is initiated by the CVS client, and then issues a message to the CVS client console if the transaction has not completed in 60 seconds. The transaction time may exceed 45 seconds due to a couple of reasons - slow network, large checkins, local replicator that the client is connecting to may be back logged.

In other words, after getting the deferred write message, the client can disconnect and WANdisco attempts to apply the changes in the background. This doesn't guarantee that the write will not be aborted by the CVS server due to an *up-to-date check failed* condition. All it means is, the user CVS sandbox doesn't need to block.

This behavior can be turned off. The message that WANdisco issues when it detects a slow write operation (exceeds the default 60 seconds timeout) :

```
WANdisco CVS Replicator has accepted the change-set. You can disconnect
the CVS client if you want. Your command will be applied to the CVS
repository even if you disconnect. After your command has been applied,
do a "cvs update" to make your sandbox consistent with the CVS reposi-
tory. Your transaction ID is NNNN
```

This behavior can be controlled via the following parameters in the `prefs.xml` file.

```
<CVSProxy>
.....
  <!-- Defaults to true -->
    <UseDeferredWrites>true</UseDeferredWrites>
  <!-- Defaults to 60s or 60000 milliseconds -->
    <ClientWaitTimeout>60000</ClientWaitTimeout>
.....
</CVSProxy>
```

You can check the completion status of your transaction by going to the Admin Console, enter the transaction ID and the site where the transaction was initiated, and click the **Show Status** button. The 0.0.0.0 IP address indicates the local site.

**Transaction Status**

Fields marked with a \* are required.

Transaction Number\*:

Site Submitted From\*:

---

**Transaction Details**

Transaction Number: 3

Command Type: PUT

User: tvaughan

From IP Address: 127.0.0.1

Command Size: 412B

Time Submitted: Fri, Feb 20, 04:07 PM PST 2009

Command File Name: svn-proposal-80027c85-ffab-11dd-bb81-001aad36533c\_7

---

Site	SCM Status	Completion Status	Completion Time
192.168.1.106:6445	Successful	Executed	-
0.0.0.0:6444	Successful	Executed	Fri, Feb 20, 04:07 PM PST 2009

If you have restarted WANdisco since the transaction was submitted or command replication has not commenced, the detailed status for the transaction is not available. The Dashboard reports the completion status of the CVS command at each site. If the command's completion status is Executed, that implies the command finished with the actual CVS status as either Successful (committed for a `cv`s commit command) or an error from CVS (for example, `up-to-date check failed`). If the command has not yet executed, the completion status could be In Progress or Scheduled.

WANdisco does not report the completion time for remote sites. The completion time field is only valid for the local site, where the transaction was submitted. The completion status is reported for each site. You can use that to figure out if the command has completed at remote sites.

## 7.8 About the Watchdog Mode

By default, WANdisco starts in watchdog mode. Whenever the replicator goes down, the watchdog mode restarts it. In watchdog mode, the replication process automatically disassociates from the terminal and becomes a daemon process, so you should not try running it in the background (with &).

If the replicator goes down because of a failed transaction, the watchdog brings up the replicator and tries the failed transaction. If the transaction fails again, the replicator goes down again. This repeats ten times, then the replicator comes up in read-only mode.

### NOTE:

---

Watchdog mode is not supported in Windows, but it is in Windows Cygwin.

---

You can turn off watchdog by typing `-nowdog`.

If WANdisco is unable to start up, for example if it terminates 10 times in quick succession, watchdog starts WANdisco in read-only mode.

```
$ ./bin/cvsreplicator -h
Usage: cvsreplicator [-v] [--verbose] [--nowdog] [--pause time]
[-email email-address]
```

<code>-v</code>	Print the cvsreplicator version
<code>-verbose</code>	Verbose, console messages go to STDOUT/STDERR instead of logs/console.txt
<code>-nowdog</code>	Turn off watchdog mode. WANdisco will not restart automatically if it terminates. Use this option for testing.
<code>-pause</code>	Time in seconds that the watchdog pauses for, before restarting service. Defaults to 0 seconds.
<code>-email</code>	Specify an email address to send an alert to, whenever the watchdog restarts or puts the replicator in read-only mode. WANdisco generates an email per local replicator activity. Set up the email account for each site with the <a href="#">Email Settings</a> , described in Chapter 4, <a href="#">Using the Admin Console</a> .

The syntax for the `-email` option is as follows:

```
$ cvs-replicator/bin/cvsreplicator --pause 5 --email "admin@blueand-
gold.com, scmadmin@blueandgold.com"
```

You can have WANdisco automatically started on system reboots. See [7.5, Setting WANdisco to Start Up on System Boot](#).

## 7.9 Temporary Files

During the normal course of running WANdisco CVS Replicator, temporary files are generated. These have the prefix `cvs-proposal-{GUID}`. By default, they are written to `cvs-replicator/log/fp` directory. This can be over-ridden using the `prefs.xml` file as following:

```
<DirPrefixMap>
<fp->/home/cvs/replicator/tmp/dir</fp->
</DirPrefixMap>
```

These files are periodically garbage-collected by WANdisco at a configurable interval.

## 7.10 Concurrency Control

WANdisco uses a local locking scheduler for ensuring consistent ordering of CVS write transactions. The locking scheduler tries to maximize the concurrency of CVS writes by executing them in parallel. You can tune the concurrency level by controlling the maximum number of threads the scheduler uses.

Modify the `cvs-replicator/config/prefs.xml` files as follows to tune this setting:

```
<CVSProxy>
.....
<writeStage>
  <MaxBufferSize>10000</MaxBufferSize>
  <!-- Concurrency of CVS locking scheduler -->
  <MaxThreads>3</MaxThreads>
</writeStage>
.....
</CVSProxy>
```

By default the max threads used by scheduler is set to 3 and the associated wait queue size is set to 10000 CVS operations.

## 8 Troubleshooting

---

### 8.1 How Do I Get WANdisco Support?

Before opening a ticket or submitting a new issue, always search the Knowledge base on [www.support.wandisco.com](http://www.support.wandisco.com).

If you want to open a ticket, you can do so at that URL.

#### 8.1.1 How Do I Run the Talkback Script?

When you do contact WANdisco with a problem, the first thing WANdisco support asks for is the talkback file. Run the file, for Unix, type

```
cv$-replicator/bin/watchdog
```

For Windows, type

```
cv$-replicator\bin\perl watchdog
```

Type in the pathname to CVSROOT when prompted. The output looks like this:

```
Please open a ticket by visiting http://support.wandisco.com and upload
the /talkback-<machine name>.zip, with a description of the issue.
```

```
Note: do not email the talkback files, only attach them via the web
ticket user interface.
```

The zip file is located at the root directory. Do not email the .zip file, just attach it to an issue at [www.support.wandisco.com](http://www.support.wandisco.com).

### 8.2 VPN, NAT, Firewall Timeouts

This section is useful if you are experiencing issues with slow commits on the non-distinguished node or if you have port-forwarding in your environment.

In a multisite configuration, most sites are connected through a WAN. Often times VPN and NAT devices are used to do IP translation and port forwarding. These devices need to maintain state in order to do the port forwarding on-the-fly. This state can grow if not cleaned out. Many devices

simply reset the internal state after an inactivity timeout. For example, some Cisco NAT routers reset state after 7200 seconds or two hours.

The WANdisco replicator uses persistent TCP connections between the replicators. If these TCP connections are going through a NAT or port forwarding device, it is important to tune the VPN and/or the TCP stack at the replicator host machine. Many NAT devices have buggy implementation that resets the internal state without resetting the TCP connections.

In such a situation, the replicators may see a connection as established but no communication actually happens. The symptoms include a slow commit that is blocking WAN communication. You can run `netstat -a | grep <DConEPort>` to see if the TCP send queues are backing up. That, in conjunction with slow commits that appear to be hanging, or frozen, typically indicates the NAT is not gracefully resetting TCP connections.

You can further confirm this by using `tcpdump` or `ethereal` to check for excessive retransmissions on the DConENet connections. You could also look at your VPN/NAT device log to see if it reset any DConENet connections that appear to be in an `ESTABLISHED` state via the `netstat -a` command.

These are a few ways of addressing the issue :

- Specify a connection keepalive timeout in the `prefs.xml` file as:

```
<DConENet> <ConnectionKeepAliveTime>1800000</ConnectionKeepAliveTime>
```

This causes inactive connections to be closed and refreshed periodically (after 1800K millis or 30 minutes).

- Increase the keep-alive timeout on the NAT/Port forwarding device. If possible, have the DConENet connections never expire. Some devices let you set port specific QoS.
- On the replicator host, tune the TCP stack to have a smaller fuse on the TCP keep alive timer. For example, on Linux, you can specify a value like 1800 (seconds) in `/proc/sys/net/ipv4/tcp_keepalive_time` to reduce the interval from default two hours to 30 minutes.
- You can restart WANdisco to kick out seemingly established connections but broken by NAT internal resets.

## 8.3 A Site Is In Read-Only Mode

If any site is in read-only mode:

- Step 1 Go to the Dashboard. You see the Problem Transactions listed for each site.

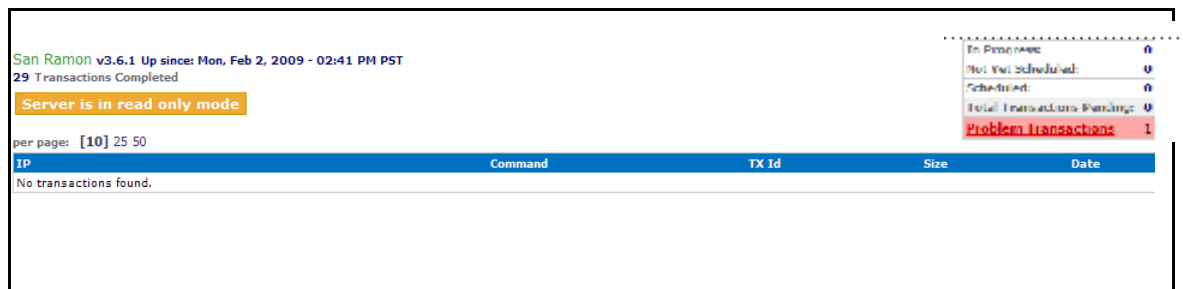

- Step 2 Click on the **Problem Transactions** link. The System tab displays a message, noting the bypassable transactions and the non-bypassable transactions.

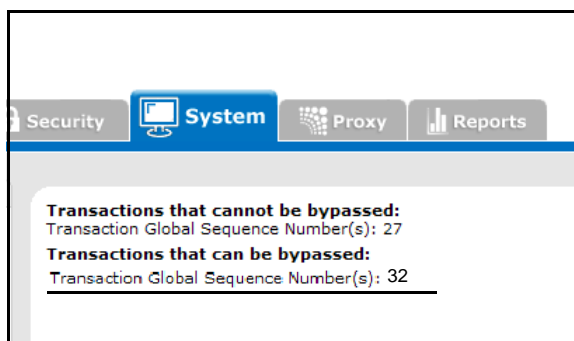

- Step 3 If there are no bypassable transactions, and you do not know why, see [8.1, How Do I Get WANdisco Support?](#)

If there are bypassable transactions, there may be one or several. Click on each transaction.

- Step 4 Read the message that returns, similar to:

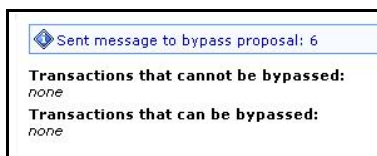

- Step 5 Verify that the Dashboard does not report any site in read-only mode.

## 8.4 Replication Processes

### 8.4.1 Connection Request Timeout Messages

Sometimes in the WANdisco logs, you see connection request timeout information messages logged. These are informational messages and should be ignored unless it is guaranteed that the connection can be established in xxx milli-seconds and happens often.

In normal operation of WANdisco, two connections are established between each of the replicated machines, a DConE connection and a DFTP connection. These two connections were established when High Availability started and are used when required. A keep-alive signal is sent on the DConE port periodically. There is no traffic on DFTP until a file transfer.

It takes between 300 to 400 milli-seconds to establish a network connection even on a slow Wide Area Network (WAN). By default, High Availability waits for 500 milli-seconds before giving up that a connection cannot be established to a peer machine and prints this informational message. What if the establishments of connection always take 501 milli-seconds. In this case, a connection is never established. To solve this problem, the timeout value is adjusted in 10% increments of the last timeout, starting at 500 milli-seconds, to a maximum of 10 seconds for each timed out connection. Upon establishment of a successful connection, this timeout value is used for subsequent connection establishment unless an adjustment is required for failed attempts.

### 8.4.2 One-to-One Mapping For cvsroot and Replicator

Each member of the replication group runs its own CVS pserver (identified by `cvs pserver host:port`). Within a CVS pserver installation, you can have multiple cvsroots (the `--allow-root` option in `inetd.conf` or `/etc/xinetd.d/cvspserver`). Within a cvsroot, you can have multiple modules or projects.

The mapping is one-to-one with CVS pserver rather than cvsroots. If you have multiple CVS servers, then you need to map each CVS server to its own replicator.

### 8.4.3 When I Commit, Why is WANdisco Being Bypassed?

Question:

I modified `/etc/services` `cvspserver` port to point to 2402. I am running WANdisco on port 2401. Everything works fine from a remote machine (not the same as `cvspserver` machine). However, whenever I do a commit from the host on which `cvspserver` is running, it seems to go directly into cvs without going through WANdisco. Why is this happening?

Answer:

Many CVS clients, including GNU cvs, look up the `/etc/services` for the port to use to connect with CVS. When you run such a CVS client on the same host as cvspserver, what ends up happening is port 2401 (default) is not used, as the `/etc/services` port has a higher precedence. The cvs client happily connects to 2402 as is the case with your cvspserver port setting in `/etc/services`, thus bypassing WANdisco.

To verify, just run with the trace on. For example:

```
$ cvs -t commit -m new
```

And you see the port as 2402, not 2401.

There are several ways to deal with this, although WANdisco recommends the last option, as it is the least error prone from an operational perspective.

- setup an environment variable `CVS_CLIENT_PORT` to 2401
- setup `CVSROOT` to explicitly specify 2401: e.g., `pserver:user@:2401/my/cvsroot`
- rename `cvspserver` to `cvspserver2` in `/etc/services` and in the `inetd.conf` or rename `/etc/xinetd.d/cvspserver` to `/etc/xinetd.d/cvspserver2`, thus avoiding any interference.

## 8.4.4 CVS: Deferred Writes with Long Transactions

WANdisco by default waits for 60 seconds when a write transaction is initiated by the CVS client, and then issues a message to the CVS client console if the transaction has not completed in that 60 seconds. The transaction time may exceed 60 seconds due to a couple of reasons: slow network or large checkins. In other words, after getting the deferred write message, the client can disconnect and WANdisco attempts to apply the changes in the background. This doesn't guarantee that the write will not be aborted by the CVS server due to an **up-to-date check failed** condition. All it means is the user CVS sandbox doesn't need to block. This behavior can be turned off.

The message that WANdisco puts out when it detects a slow write operation (an operation that exceeds the default 60 seconds) :

```
cvs write: Security has accepted the change-set. You can disconnect the
CVS client if you want, changes will be applied automatically on your
behalf.
```

This behavior can be controlled in the `prefs.xml` file.

```
<CVSProxy>
.....
<!-- Defaults to true -->
```

```
<UseDeferredWrites>>true</UseDeferredWrites>
<!-- Defaults to 60s or 60000 milliseconds -->
<ClientWaitTimeout>60000<ClientWaitTimeout>
</CVSProxy>
```

## 8.4.5 WinCVS Client Responds “Exited Normally with Code 1”

Why am I getting this message when the normal exit code is 0? (Seen in WinCVS client version 2.0.2.4 build 4, using compression level 5.)

I added a 300 mbyte file (`cvs add`) successfully. Upon commit, the client responded, after a long delay, with the message `exited normally with code 1`. I confirmed that WANdisco successfully committed the transaction (the large file was in the repository, and the WANdisco logs indicated a successful commit).

The sandbox still shows the large file as `added but not committed`. The updates from WinCVS failed with "exited normally with code 1". I deleted the large file from the sandbox and tried to update, but I still had the same problem.

What finally worked was that I deleted the sandbox, and checked it out again. Everything works fine now.

## 8.4.6 WinCVS Wants Passphrase - SSH Access to WANdisco

Why is WinCVS prompting me for a passphrase when I use SSH access to WANdisco?

This is not a WANdisco issue. Ensure `pageant` or `ssh-agent` is running with private keys already loaded. A less secure way is to have no passphrase on the private keys at creation time.

## 8.4.7 With WinCVS and SSH, Commits Not Replicated

Ensure `cvsrelay` is being picked up as the `cvs` executable by `sshd`. This can be accomplished by setting up the `CVS_SERVER` environment variable in the Windows system variables dialog box or renaming `cvs` to point to `cvsrelay`. A write or a commit operation is replicated only if it is submitted to WANdisco. Bypassing WANdisco changes the CVS repository directly.

Remember to look for the following pattern in the logs/`ProxyServer*.log` to know if WANdisco even got the write or commit changes:

```
...
INFO: [reader-2] Submitted after verification: cvs-proposal-2f195a4b-
dea9-11d9-b140-00065b193ef5_4
1118955513564 org.nirala.communication.transport.cvsproxy.CVSProposal
output
INFO: [gsn-1] Executing cvs-proposal-2f195a4b-dea9-11d9-b140-
```

```
00065b193ef5_4
1118955513575 org.nirala.communication.transport.cvsproxy.CVSProposal
onCommit
INFO: [reader-1] Committed CVS transaction cvs-proposal-2f195a4b-dea9-
11d9-b140-00065b193ef5_4

...
```

If you don't see a `Submitted` line in the log file, the CVS write operation never made it to WANdisco.

Also check the host and port setting in `/etc/prefs.conf`.

If you still have trouble, run `cvsrelay` with a `-v` option. Set the Windows environment variable `CVS_SERVER` with `-v` option to `cvsrelay` (for example, `.../bin/cvsrelay -v`). This causes a good amount of logging to `syslog` on the host on which `sshd` is running. You can diagnose the problem by looking at the `syslog`.

## 8.4.8 No Submitted Lines in Log File After Commits

The most common reason for this situation is an incorrectly set up `CVSROOT` environment variable. For example, if the `CVSROOT` environment variable is set up as `/home/cvs`, then the CVS client directly modifies the repository using the local access protocol.

The `CVSROOT` environment variable needs to be set up as:

```
$ setenv CVSROOT :pserver:@:/
```

If WANdisco is running on port 2401, then the WANdisco port setting can be skipped unless you are running on the same host as `cvs pserver` repository.

## 8.5 Error Messages

### 8.5.1 Why Am I Getting Permission Errors for Files?

If you're getting file permission errors, check the file permissions for the `run-as`, or `Default User`.

CVS clients, even without WANdisco, use the same `run-as`, or `default`, user name to access the CVS server. The password file syntax is: `username:encrypted password:run-as username`.

If WANdisco is controlling the password file, you must set the `run-as` user in WANdisco. There can only be one active `run-as` user at a time. Since you probably had a `run-as` user set up before

WANdisco, you should enter that same run-as user in WANdisco. Go to the Proxy page, and select **CVS Settings**. Enter the run-as user in the **Default User** field, and click **Save**.

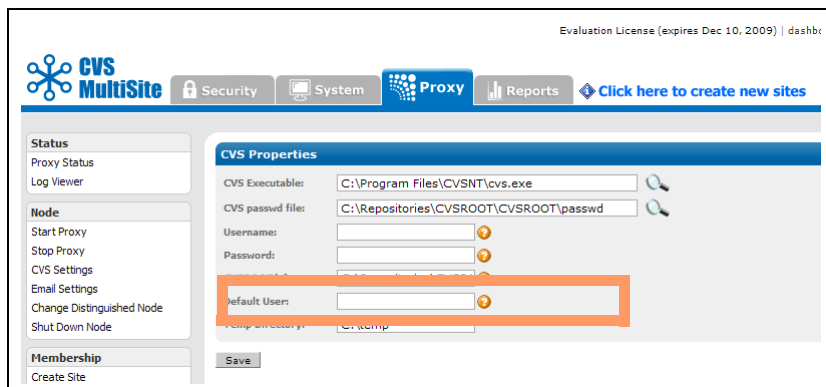

Any time you modify the Default User, you must edit the password file and update the run-as usernames for all CVS users.

## 8.5.2 Replicator Aporting with System Error Message

The symptoms are as follows in one of the logs/Proxy\* log file:

```
SEVERE: [reader-1] Encountered a system error from CVS server : error 0 /
home/cvsroot/dir2: no such repository The CVS command file is:.... Above
error constitutes a system error according to the CVS error catalog.
Shutting down. Please verify setup and ensure repositories are in sync
before starting
```

or

```
SEVERE: [reader-1] Encountered a system error from CVS server : E cvs
[tag aborted]: could not open lock file `~/cvsd/root/module/,Run.java,' :
Permission denied
```

The same transaction commits at other sites where the repository structure and file level permissions are fine.

The cause for this is the directory does not exist, or write permissions are missing at the other replicator site. The repository structure must be the same at all sites for replication to occur. Create the same repository at the errored site and re-start the replicator. It then applies pending transaction to the repository.

## 8.5.3 Aborted CVS Transaction with “I HATE YOU” Message

### Question

We are seeing the following stack trace in the log file and the CVS replicator is shutting down.

```
1122522454973 org.nirala.communication.transport.cvsproxy.state.  
ResponseGatherState writeModeException  
SEVERE: [reader-1] Exception encountered in write mode: previous line:  
null  
current line: I HATE YOU  
countResponses: 0  
countOKsPriorToFirstWrite: 2  
countOKsAtCompression: 0  
totalOKs: 3, server state :STATE : (ResponseGatherState) , txn# - null,  
terminator is ON : true, null  
  
org.nirala.communication.transport.DConeNet.exceptions.SocketException:  
java.io.IOException: Connection reset by peer  
at sun.nio.ch.FileDispatcher.read0(Native Method)  
at sun.nio.ch.SocketDispatcher.read(SocketDispatcher.java:21)  
at sun.nio.ch.IOUtil.readIntoNativeBuffer(IOUtil.java:233)  
at sun.nio.ch.IOUtil.read(IOUtil.java:206)  
at sun.nio.ch.SocketChannelImpl.read(SocketChannelImpl.java:207)  
at org.nirala.communication.transport.DConeNet.TCPPeerConnection.read(TCP-  
PeerConnection.java:410)  
.....  
.....  
erRunnable.run(ReadReactor.java:164)  
at java.lang.Thread.run(Thread.java:595)  
  
1122522454974 org.nirala.exceptions.BaseException onFatalException  
  
SEVERE: [reader-1] Aborted CVS transaction cvs-proposal-d7bc8409-ff51-  
11d9-8d6a-0011110ee979_18 due to errors from CVS repository.
```

Resolve the errors from CVS and then restart. Most of the time a restart fixes the problem. If a restart doesn't work, please verify that the repositories are in sync, delete `logs/tmp` at all replicas before resuming operation.

### Answer

Whenever you see the log ending with an `Aborted CVS transaction...` please look at the previous log line. (Each line starts with a long 13 digit timestamp). In this case the previous line indicated the replicator received an `I HATE YOU` message from the CVS server. This happens if the CVS user or password do not match across replicas. In other words, a commit with a password X on site 1 and password Y on site 2 for the same user causes the replicated commit to be rejected in the second replica.

Don't worry, the replicator preserves the commit in its transaction log. So simply fix the password, restart, and the changes are applied.

When the replicator encounters such an error, it does an automatic shutdown to prevent further repository evolution until the administrator can fix the password or user name.

## 8.5.4 Missing License Key File

CVS MultiSite depends on a license key file being present in the `cvs-security/config` directory. Please get a valid license from WANdisco and copy the file to the config directory. WANdisco does not start without the license file.

## 8.5.5 I'm Getting a SEVERE Exception

I'm getting a SEVERE exception, and replicator is aborting the CVS transaction and shutting down.

If you get a message in the `logs/Proxy*.log` file similar to

```
SEVERE: [reader-1] Encountered a system error from CVS server : E cvs
[commit aborted]: could not find desired version 1.16 in /development/
software/cvsroot/libcobra/Build,v
```

it means the replicator has detected an out of sync condition. Remember the replicator continuously monitors your repository for any out of sync issues. If it detects this has occurred, it triggers an automatic shutdown to prevent further corruption.

This could happen if someone accidentally committed directly to CVS, bypassing the replicator, and ramped up the version in one site without giving the replicator any chance of replicating. This can be easily resolved by following the reset procedure outlined in the knowledge base article [Reset procedure](#).

Follow all precaution to avoid bypassing the replicator:

- Step 1     Ensure only cvsreplicator host/IP address is allowed to connect to cvspserver.
- Step 2     Protect direct logins in cvs replicator or cvs pserver box from end user.
- Step 3     When administering, ensure a valid `CVSROOT` that points to the replicator.
- Step 4     Avoid the cvspserver port issue, (see [8.4.3, When I Commit, Why is WANdisco Being Bypassed?](#)).

## 8.6 WinCVS - Timeouts Large Commits Can Corrupt Sandbox

Joe added a 300 MB file (cvs add) successfully. Upon the commit, the client responded (after a long delay) exited normally with code 1. The usual normal exit code is 0.

Joe confirmed that WANdisco successfully committed the transaction. The large file was in the repository, and WANdisco logs indicated a successful commit. The sandbox still showed the large file as added but not committed. Updates from WINcvs failed, giving a message exited normally with code 1.

Joe deleted the large file from the sandbox, and tried to update, but still found the same problem. Joe deleted the sandbox and checked the file out again, and got no further error messages.

## 8.7 Oops!

### 8.7.1 I Directly Committed to CVS, How Do I Rsync?

If you bypassed the replicator, you can reset the replicator state with these steps:

Step 1 Shut down all replicators.

Step 2 Reset each replicator. For Unix, type

```
$ cvs-replicator/bin/reset
```

For Windows, type

```
cvs-replicator\bin\perl reset
```

Step 3 If this happened during an initial setup/evaluation stage, delete the old project in CVS and create a new one.

If this happened on a production repository, just re-sync all the repositories to the same state/data.

Step 4 Restart all the replicators.

**NOTE:**

---

It is very important that you take all precautions to avoid directly checking in or committing to the backend CVS repository.

---

## 8.7.2 I'm Getting a SEVERE Exception

I'm getting a SEVERE exception, and replicator is aborting the CVS transaction and shutting down.

If you get a message in the logs/Proxy\*.log file similar to

```
SEVERE: [reader-1] Encountered a system error from CVS server : E cvs
[commit aborted]: could not find desired version 1.16 in /development/
software/cvsroot/libcobra/Build,v
```

it means the replicator has detected an out of sync condition. Remember the replicator continuously monitors your repository for any out of sync issues. If it detects this has occurred, it triggers an automatic shutdown to prevent further corruption.

This could happen if someone accidentally committed directly to CVS, bypassing the replicator, and ramped up the version in one site without giving the replicator any chance of replicating. This can be easily resolved by following the reset procedure outlined in the knowledge base article (See [8.7.3, I Pressed Ctrl-C During a CVS Command!](#)).

Follow all precaution to avoid bypassing the replicator:

- Step 1     Ensure only cvsreplicator host/IP address is allowed to connect to cvspserver.
- Step 2     Protect direct logins in cvs replicator or cvs pserver box from end user.
- Step 3     When administering, ensure a valid CVSROOT that points to the replicator.
- Step 4     Avoid the cvspserver port issue, (see [8.4.3, When I Commit, Why is WANdisco Being Bypassed?](#)).

## 8.7.3 I Pressed Ctrl-C During a CVS Command!

If you were executing a read command (a command that does not modify the CVS repository), you do not have to do anything.

If you were executing a write command, update your sandbox after WANdisco has applied the command to the repository.

In addition, if you were adding files to the repository (either cvs import or cvs add, followed by cvs commit), wait until you update your sandbox before you continue to use it.

## 8.7.4 CVS Login Appears to Hang

After setting up a new replicator instance, you may try to do a CVS login via the replicator, but the login seems to hang. You may see a message such as:

```
[user@pee ~/tmp/src]$ cvs -d :pserver:user@tao:2801/home/cvsroot login
Logging in to :pserver:user@tao:2801/home/cvsroot
CVS password:
```

After you type the password, the login appears to hang.

The vast majority of the time, an invalid IP or host name causes this. For example, here we have the user specifying `tao` as the WANdisco host name instead of `pee`. This causes the CVS client to do a connect to `tao` WANdisco, which may be behind the firewall, or port 2801 on `tao` is not exposed through the firewall. The TCP connection never completes. It can take several minutes to detect a connection failure, unless the host with the IP address itself is down. If the external IP address points to a firewall or a router, from the TCP perspective, this is just a slow connection issue, and the TCP stack would send the `SYN` packet and block.

You can confirm this by running with `-t` option to the CVS client.

```
[user@pee ~/tmp/src]$ cvs -t -d :pserver:user@tao:2801/home/cvsroot
login
-> main: Session ID is 630242e861f94567
-> main loop with CVSRROOT=/home/cvsroot
Logging in to :pserver:user@tao:2801/home/cvsroot
CVS password:
-> Connecting to tao(67.160.228.194):2801.
cvs [login aborted]: connect to tao(67.160.228.194):2801 failed: Connec-
tion timed out
```

You can see the CVS client timing out. The user really wanted to connect with WANdisco on `pee` but mistakenly specified `tao`.

## 8.8 CVSNT Generates CVSLock Error Message

### Problem

When I connect to WANdisco for my CVSNT repository, I get the message

```
cvcs [login aborted]: unrecognized auth response from localhost: CVSLock  
2.2 Ready
```

### Solution

Make sure WANdisco is configured to connect to the CVSNT server port and NOT the CVSNT lock daemon port. This message comes from the CVSNT lock daemon. You can go to the CVSNT control panel and change the server and lock daemon ports.

## 9 Frequently Asked Questions

---

### 9.1 Why Are So Many Java Processes Running?

On older versions of Linux, every thread is listed as a process by the `ps` command. This does not affect the operation of WANdisco. WANdisco does not support the older versions of Linux.

### 9.2 Do I Need the Same CVS Version for All Servers?

Yes. WANdisco talks with the CVS server using the standard CVS wire protocol. The server side protocol can change with server versions. That is why it is imperative that the versions match. You can find the versions by running :

```
$ cvs -d :pserver:user@:/your/cvsroot version
```

Note the version argument has no minus (as in `-version`). Without the minus you are able to print the client and server versions. Make sure all replicas have exact same server versions. Client versions can vary, but of course must be compatible with your server version.

### 9.3 Can I Store Logs or Content on NFS?

NFS (Network File System) allows files and directories to be accessed remotely over a network using NFS clients. NFS clients are typically built into the operation system kernel these days. However, some operations, like renaming a file, are not guaranteed to be atomic over NFS. Here is a snippet from the `rename` function's `man` page on Linux, for example:

#### BUGS

```
On NFS filesystems, you can not assume that if the operation failed the file was not renamed. If the server does the rename operation and then crashes, the retransmitted RPC which will be processed when the server is up again causes a failure. The application is expected to deal with this. See link(2) for a similar problem.
```

Code management systems such as CVS make heavy use of the `rename` operation to modify the underlying databases. Independent of WANdisco, it is a risky practice to store CVS database content on NFS. The code management community at large recommends not using NFS for storing repositories.

WANdisco High Availability is bundled with a built-in transactional journal and an object database. These are by default stored in the `cvs-ha/systemdb` and `cvs-ha/config` directories.

These directories should not be mounted on an NFS drive. The replicator itself may be installed on an NFS drive but the systemdb and config directories should be on direct storage (non-NFS options like RAID, SCSI, SAN, etc). Replicator's transactional integrity can be compromised if writes to an NFS server are lost due to a potential NFS client cache crash after the NFS server has indicated IO completion.

## 9.4 Why is Set Up Configuring IP Addresses as 0.0.0.0?

The address 0.0.0.0 is a special IP address, treated as a wild-card IP address. In other words, on a machine with multiple NICs (Network Interface Cards), it binds to all interfaces. The advantages of using wild-card IP address include:

- It avoids binding to a fixed IP address. If the host's IP address changes, (for example, the subnet changes, or the machine is moved to a different location) you don't have to change the wild-card IP in the prefs.xml file to the new IP address.
- There is wider bandwidth to TCP clients. Now TCP clients can connect to any NIC, because WANdisco is listening on multiple NICs.

The disadvantage to using the wild-card IP is that it gives coarser access control at the IP address level, as all address are being listened to at the specified port.

You can always switch from the wildcard IP address to a fixed, static IP address or a DNS host-name, though for the most part, WANdisco recommends you stick with wild-card addressing.

## 9.5 Should I Worry About Time Changes?

Time changes and time zones have no effect on the operation of WANdisco.

## 9.6 Does WANdisco Support Dynamic DNS?

Yes, WANdisco supports dynamic DNS, but strongly discourages its use.

If a hostname is specified during the setup process, WANdisco requires that it should be able to connect to a valid DNS and resolve the hostname to valid IP address upon startup. If the host-name cannot be resolved to an IP (either by not being able to connect to DNS, or no entry is found at the given hostname), WANdisco dies gracefully. This has never been a problem during production and with static IPs.

However, if dynamic DNS support is required, please modify the `prefs.xml` file at each site and set `UseDynamicDNS` to `true` in `DConeNet` element.

```
<Preferences>
...
<DConeNet>
...
  <UseDynamicDNS>true</UseDynamicDNS>
</DConeNet>
```

In addition, the following Java security properties should be set to different Time-to-live (TTL).

```
networkaddress.cache.ttl
networkaddress.cache.negative.ttl
```

Please read [InetAddress Caching](#) for more details.

## 9.7 Can I Use SSH Tunnel to Navigate a Firewall?

You can use SSH tunnels to test connectivity to a replicator's DConeNet port through a firewall.

**NOTE:**

---

SSH tunnels are not recommended for a production environment.

---

SSH tunnels are temporarily created using a secure shell. If the shell hangs up for any reason, the tunnel goes away. You don't want the connectivity to a replicator's WAN port to be dependent on a transient shell. We recommend using permanent IPsec tunnels (VPN/NAT devices can help) for navigating firewalls.

For deferred writes with long transactions: The replicator by default waits for 60 seconds when a write transaction is initiated by the CVS client, then issues a message to the CVS client console if the transaction has not completed in 60 seconds. The transaction time may exceed 60 seconds due to a couple of reasons: slow network, large chickens, local replicator that the client is connecting to may be back logged. In other words, the client, after getting the deferred write message, can disconnect, and the replicator attempts to apply the changes in the background. This doesn't guarantee that the write will not be aborted by the CVS server due to the "upto-date check failed" condition. All it means is the user CVS sandbox doesn't need to block. This behavior can be turned off.

The message that the replicator puts out when it detects a slow write operation (exceeds the default 60 second time): cvs write: Replicator has accepted the change-set. You can disconnect the CVS client if you want, changes will be applied automatically on your behalf.

This behavior can be controlled in the Prefs.xml file. Look for `UseDeferredWrites`.

```
<CVSProxy>
.....
<!-- Defaults to true -->
```

```
<UseDeferredWrites>true</UseDeferredWrites>
<!-- Defaults to 60s or 60000 milliseconds -->
<ClientWaitTimeout>60000<ClientWaitTimeout>
</CVSProxy>
```

## 9.8 CVS Tagging and Branching Support

### Question

Tagging and branching end up touching all the files in a module. Does each file have to be resynched between repositories? Does this affect the time it would take to tag or branch across replicas?

### Answer

First of all, replication is invisible to the user: the user operates CVS normally. Replication is a transparent network proxy from a CVS client perspective.

Tagging and branching are treated as a write operation from the CVS perspective, as they change state on disk. The operations are propagated to all replicas.

The way the WANdisco CVS replicator works, files are not directly synced between repositories. This is vastly different from CVSup or rsync based approaches.

The logical tag or branch command is replicated to all the CVS repositories. From a CVS client perspective, you only block for your local CVS repository to finish the CVS command (in the example, that would be tag or branch). So any latency you are likely to see is local access only.

This also reduces the network bandwidth utilization, as the tag/branch command being replicated is typically a lot smaller compared to the modified file state on disk that would have to be copied (even using incremental copy) with rsync based approaches. For instance, a repository with 10000 files (10k each) on tagging causes rsync or any disk based tool to copy 10000 files, as each changed due to new tagging. This could be hundreds of megabytes in network transfer. With the replicator, the tag command itself is replicated, which is just a few hundred bytes.

The remote replicas (there can be any number of them) apply the tag or branch command in the correct sequence. When another write operation (tag,commit,admin, etc.) arrives at the remote repository, it is already properly ordered to ensure all replicas stay consistent with each other.

## 9.9 Using SSH Access With NIS-based User Database

You can use NIS. There are several ways to configure SSH and CVS security.

### Question

As I was going through the SSH support section in the CVS Replicator Administration Guide, I found that if I use the SSH Direct method that uses the `cvsrelay` executable that in turn gets invoked by `sshd`, I need to also set up the CVS server's password database file in `$CVSROOT/CVSROOT/passwd`. Is it mandatory to set up this file? Can I avoid setting up this file and instead use the centralized NIS authentication to verify user credentials?

Answer

Yes, you can use NIS. Basically, if you are using SSH, it is really `SShd` that authenticates the user's incoming password. `SShd` can be set up via `/etc/ssh/sshd_config` (or wherever your config file is) to permit NIS/NIS\_PLUS authentication. Note this is independent of the CVS replicator.

Once `SShd` successfully completes NIS authentication, it then invokes the `cvsrelay` executable. Without `cvsrelay`, `SShd` forks a CVS process with `setuid` to the user it just authenticated. There is no password checking done by CVS itself then. In other words, CVS does not consult the `CVSROOT/passwd` file or NIS when using `SShd`! This is normal CVS behavior, without the CVS replicator in the picture.

With `cvsrelay`, we avoid the forking of CVS replicator. That requires `cvsrelay` to pass a valid user and a dummy password to replicator. WANdisco can supply you with scripts that add entries in the `CVSROOT/passwd` file without manually modifying it. Alternatively, you can have the `CVSROOT/passwd` file with an empty password, and then no password checking is done at the CVS level (this is only secure if that user only comes through SSH).

If you want to use both `SSHD-NIS` authentication and `CVS-NIS` authentication (in case some users come through SSH and some directly using CVS `pserver`), that is also possible to set up. CVS server looks for user's password first in `CVSROOT/passwd`. If it is not found, it then uses the system PAM. PAM can be configured to use NIS, LDAP, etc.

In summary, NIS can be used. There are several ways to configure SSH and CVS security.

## 9.10 How Do I Know `cvsrelay` is Being Invoked?

First check the system log (on Linux: `/var/log/messages`), for any error messages from `cvsrelay`. A sample error:

```
tao /var/log# pwd
/var/log
tao /var/log# grep cvsrelay messages
Dec 1 21:02:04 tao cvs-replicator/bin/cvsrelay[15105]: failed to open /
etc/prefs.conf
Feb 24 22:03:07 tao ./cvsrelay[5348]: cvs: delegated login failure.
Check syslog
for further info. Server response - "error 0 /tmp/cvstest: no such repos-
itory"
```

You can also setup `cvsrelay` to run in verbose mode by passing an optional `-v` parameter.

```
setenv CVS_SERVER "...../bin/cvsrelay -v"
```

This causes the system log (on Linux: `/var/log/messages`) to contain detailed messages from `cvsrelay`.

## 9.11 Advisory: CVS Add Bug in All CVS Client Versions

A CVS add operation can corrupt the CVS user's sandbox if the CVS server fails or aborts the command due to a permissions issue, server crash, etc. The CVS add does not wait for the server to finish the CVS add operation on the server side; it adds the CVS directory locally, thus confusing the sandbox if the server fails to add. If the user later tries to commit files in the directory that was never added to the cvs server, the cvs server issues a **no such directory** exception. This can cause the replicated repository to go out of sync. See the cvs bug report [http://savannah.nongnu.org/bugs/?func=detailitem&item\\_id=15797](http://savannah.nongnu.org/bugs/?func=detailitem&item_id=15797) for more details.

To recover from such an error, add the missing directory to the CVS server manually and restart the replicator.

WANdisco also provides a `commitinfo` trigger that can catch the add bug and report an error to the CVS client before any replication has occurred. It is highly recommended that you use or incorporate this trigger in your existing pre-commit `commitinfo` trigger. For the download link, see [6.14, Using CVS Triggers for Sending E-mails](#).

## 9.12 Advisory: Zlib Compression Bug in 1.12.12, 1.12.13

WANdisco recently discovered a bug in CVS 1.12.13 that causes several CVS clients, including the WANdisco replicator, to block indefinitely, as CVS server's zlib implementation gets hung while parsing zlib compressed files. A bug and a fix has been posted with the CVS project team: see [https://savannah.nongnu.org/bugs/?func=detailitem&item\\_id=14840](https://savannah.nongnu.org/bugs/?func=detailitem&item_id=14840) for more details.

The CVS community is to release a fix in version 1.12.14 to address the bug. Until then, we recommend the following workaround.

- Recompile CVS 1.12.12 sources with `configure -with-external-zlib` after ensuring the `libz.so` on the system is not 1.2.2. On Red hat linux, the default version is typically 1.1.14. This can be determined for example by looking at the link `/usr/lib/libz.so` points to.

We have tested with the latest zlib (1.2.3 at the time of writing) from <http://www.zlib.net/> and it works with CVS 1.12.12 and `configure --with-external-zlib`.

If you compile zlib, make sure you run `configure` with `--shared` option and ensure `LD_LIBRARY_PATH` points to the path of the newly compiled `libz.so`.

## 9.13 Advisory: Avoid Force Commit with CVS Commits

The CVS commit command supports a `-f` or a `Force Commit` option that can be used to force the revision of the file to be incremented, even if the file has not changed. It is a dangerous option, as the developer may sometimes hit commit twice from the CVS client if for any reason they do not get communication back from the CVS server that the command was completed. This causes unnecessary incrementation of revisions.

The situation in the previous scenario is benign. However, if the replicator detects a CVS server crash, it can retry the command at the site where the crash was detected. If the CVS server had in fact completed the command, but failed to notify the replicator before it crashed, this would cause revision numbers to go out of sync across the replication group.

A future release of the replicator will work around this problem. Until then, we recommend not using the force commit option.

## 9.14 Advisory: CVS 1.12.13 Bug In Import

We have recently discovered a bug in cvs server 1.12.13 that causes "cvs import with a `-n` option" to fail. A bug has been filed with the CVS project team, see [http://savannah.nongnu.org/bugs/?func=detailitem&item\\_id=15703](http://savannah.nongnu.org/bugs/?func=detailitem&item_id=15703) for more details.

If you are using cvs server 1.12.13, you will want to switch off the verify mode (impact performance degradation) in the replicator to avoid the bug. See <http://www.wandisco.com/techpubs/cvsmanual/node18.html> for more details.

Alternatively you could move to cvs server 1.11.21 with WANdisco keyword patch [http://support.wandisco.com/index.php?\\_m=downloads&\\_a=view&parentcategoryid=4&pcid=0&nav=0](http://support.wandisco.com/index.php?_m=downloads&_a=view&parentcategoryid=4&pcid=0&nav=0).

## 9.15 WANdisco Authentication

Authentication is the process of determining whether someone or something is, in fact, who or what it is declared to be. Authorization is the process of giving someone permission to do or have something.

WANdisco is compatible with CVS, among other SCM tools. There is a variety of forms of authentication for each.

### 9.15.1 CVS Password

CVS Password is the WANdisco-recommended method of authentication. The CVS user/passwords on all repository hosts must match. WANdisco recommends that the CVS passwords are set in the `username;password;user` schema. The CVS password files should be under CVS control, so that they are replicated throughout the replication group. This is required because the

WANdisco CVS replicator creates a peer-to-peer replication system. Any replica of the CVS repository is accessible by every valid CVS user. To ensure that the passwd files stay in sync at all sites, navigate to the `checkoutlist` file, which is in the `CVSROOT` directory, and insert the line `passwd Could not update CVSROOT/passwd`. This causes an error message if the file cannot be checked out.

## 9.16 How WANdisco Handles CVS Authentication

WANdisco supports the following protocols: `pserver`, `ext` (ssh) and `gserver`. Authentication is always done by CVS, regardless of the protocol being used. This authentication is done at each site individually. Any PAM can be used with CVS plus WANdisco as long as you use one of the mentioned protocols.

As authentication is done at each site, a user has to exist with correct credentials at all the sites. With `pserver` protocol and **SystemAuth** set to **no**, CVS consults `CVSROOT/passwd` file. The entries defined in this password file have the format `username:password[:run-as-username]`. This user does not have to be created at all the sites, but the user does need to be defined in the `CVSROOT/passwd` file at all the sites.

If we follow the A:B:C format, that is, `run-as-username`, then only one physical user has to be created, and it becomes easy to manage the users using the `CVSROOT/passwd` file. The CVS daemon runs as **cvuser**, and this **cvuser** is the only user that has any read/write privileges to the repository. Note that in the `cv-log`, the entry is made for the actual user doing the changes, not **cvuser**.

You can change the user back to **root**, but make sure that the user has read/write permission to the CVS repository, and the user physically exists, and belongs to the correct group. This may cause extra administrative work in the distributed environment, but if you choose to do it, WANdisco does not prevent you.

For the authorization part, WANdisco needs to find out the username from the input byte stream. This information is readily available with `pserver` protocol, but not with `ext` and `gserver` protocol.

To support the later protocols, WANdisco has written appropriate relays. These relays interpret the authentication portion of the input stream, and pass it to CVS for authentication. After successful authentication, this relay gets the username from either CVS or the system, replaces the authentication portion of the input stream to `pserver` protocol with the username (and a dummy password) and replicates.

Note that the user has already been authenticated with `ext` and `gserver` (kerbrosse, LDAP, etc.). CVS is configured to use the `CVSROOT/passwd` file for `pserver` protocol, and now the password file has username with dummy password. The fake authentication succeeds and WANdisco replicates it at all sites. That is how `ext` and `gserver` protocol are implemented.

The *WANdisco CVS Replicator installation/User guide* discusses in detail how to set up the system for `ext` (ssh) protocol. The same setup applies to `gserver` protocol. The relay for SSH is distributed with the standard product and you should have it. The relay for `gserver` is not distributed and has to be coordinated with the sales team.

## 9.17 About WANdisco Log Files

WANdisco uses Java logging. See

<http://java.sun.com/j2se/1.4.2/docs/guide/util/logging/overview.html> for a discussion on Java logging. Make any changes to the `cvs-replicator/config/log.properties` file.

WANdisco places the log files in `cvs-replicator/logs`. The current file is always `Proxy-Server-prefs.log.0`, and the files are rotated out and eventually garbage collected. For rotation schedule, see the `cvs-replicator/config/log.properties` file.

Here is a brief explanation of Java logging. The newest log is always `log.0`. When that log reaches a specified size (500 KB by default), that log gets renamed to `log.1` and a new `log.0` is started. The old `log.1` becomes `log.2`, `log.2` becomes `log.3` and so on. The second newest log is always `log.1`. WANdisco's Log Viewer displays a drop-down list showing the other logs. As the log file names increment higher, they represent going further back in time.

If you want to change the defaults on the file size before log rotation and how many logs to keep, change these parameters in `svn-replicator/config/log.properties`:

```
java.util.logging.FileHandler.limit = 500000
java.util.logging.FileHandler.count = 500
```

The limit is in bytes and the count is the maximum number of logs to keep. Any changes to `log.properties` are unique to each site, and are not replicated.

# Appendix A - Installing Java and Perl

---

You should have already installed Java and Perl at all the sites in your replication group for your trial evaluation. However, any new site you add to the replication group needs Java and Perl installed as well.

## Installing Java

- Step 1 Install JDK 1.5 and define the `JAVA_HOME` environment variable to point to the directory where the JDK is installed. You can download JDK 1.5 from the URL below.

```
http://java.sun.com/javase/downloads/index_jdk5.jsp
```

- Step 2 Add `$JAVA_HOME/bin` to the path and ensure that no other java (JDK or JRE) is on the path.

```
$ which java
/usr/bin/java
```

```
$export JAVA_HOME="/usr"
```

or

```
$which java
/export/share/apps/jdk/1.5.0/bin/java
```

```
$export JAVA_HOME="/export/share/apps/jdk/1.5.0"
```

- Step 3 Ensure the full JDK is installed, not just the JRE. This can be confirmed by running `java -server-version`. If it generates a **not found** error, repeat Steps 1 and 2.

If you find package management problems or conflicts with the JDK version you are downloading (for example, rpm download for Linux), you may want to use the self-extracting download file instead of the rpm (on Linux) package. The self-extracting download easily installs in any directory without any dependency checks.

## Installing Perl

- Step 1 On UNIX or Cygwin, install perl version 5.6 or greater and ensure that the perl executable is on the system path.
- Step 2 On Windows, install ActivePerl version 5.8 or greater and ensure that the perl executable is on the system path. You can download the MSI installer for ActivePerl from the URL below.

`http://activestate.com/Products/Download/Download.plex?id=ActivePerl`.